



B-TECH AUDIO VIDEO MOUNTS

PRESENTS THE SYSTEM **X**™ RANGE OF...

PROFESSIONAL AV MOUNTING SOLUTIONS



WELCOME



TO THE SYSTEM X RANGE OF PREMIUM MOUNTING SOLUTIONS

Having already shipped a record number of units since its launch, System X has quickly become one of B-Tech's most sought after product ranges and has been selected as a technology finalist in the 2016 InAVation Awards - in the AV Mounting & Accessory category. The range consists of premium mounting solutions for video walls, digital signage and menu boards and the latest additions to the range expand its capabilities even further, adding solutions for XL screens such as 84", 95" or even larger, as well as bolstering its capabilities for the broadcast and video conferencing markets.

The mounting system is lightweight yet incredibly strong and has a high-end aesthetic quality which gives a premium finish without sacrificing any of the reliability that B-Tech products are renowned for. The range is universally compatible with all video wall screens and is available in an almost endless variety of configurations - in off-the-shelf kits for common setups or in a modular component form for custom requirements.

OFF-THE-SHELF SOLUTIONS

Mounting solutions which cater for the most common video wall and menu board requirements are available in ready-made kits with the same quick turnaround that you would get with any B-Tech product lines. Variations of these kits can be configured to your requirements using the System X online configuration tool - just specify a few simple details, such as number of screens and their size, and the tool will configure a kit for you. Please see **pages 4-17** for detailed information about the off-the-shelf kits that are available.

INDIVIDUAL COMPONENTS

In some instances it may be beneficial to order components individually rather than as part of a kit. Holding stock of components means orders can always be fulfilled quickly - whether for a standard off-the-shelf kit or an entirely bespoke configuration. Please see **pages 20-34** for information about the components used in System X installations and how they are used to create a complete mounting solution.

SYSTEM X™



CONNECT WITH B-TECH ONLINE

There are various ways to connect with B-Tech online and on social media sites such as Twitter, LinkedIn and YouTube.

WWW.BTECHAVMOUNTS.COM



@BTECHAVMOUNTS



B-TECH INTERNATIONAL LTD.



BTECH AV MOUNTS



PRODUCT INFORMATION ICONS FOUND THROUGHOUT THIS CATALOGUE



Max VESA® Size



Recommended Maximum Screen Size



Weight Limit



Post Installation Screen Alignment



Tilt Range



Black



Silver



Chrome



Black or Silver



B-TECH PROFESSIONAL



For More Information Visit www.btechavmounts.com

CONTENTS

OFF-THE-SHELF SYSTEM X KITS

VIDEO WALL AND MENU BOARD MOUNTS	P.4-17
BT8370-2X2 Universal Video Wall Stand	6
BT8370-3X3 Universal Video Wall Stand	8
BT8371-2X2 Universal Mobile Video Wall Stand	10
BT8371-3X3 Universal Mobile Video Wall Stand	12
BT8330 Universal Menu Board Mounting System	14
BT8340 Universal Video Wall Mounting System	16

SYSTEM X COMPONENTS & HOW TO USE THEM

FLOOR BASES AND SUPPORT COLUMNS P.20

BT8380 Vertical Support Columns
BT8380-CPL Support Column Coupler
BT8380-BASE Trolley Base for Support Columns
BT8380-CASTORS Castors for Trolley Base
BT8380-FBFK Bolt Down Kit for Trolley Base
BT8380-BASEM Freestanding Floor Base for Support Columns - Medium
BT8380-BASEL Freestanding Floor Base for Support Columns - Large
BT8380-FFB Bolt Down Floor Base for Support Columns

MOUNTING RAILS AND FIXING KITS P.22

BT8390 Horizontal Mounting Rails
BT8390-EXT Extension Bars to join Mounting Rails
BT8390-SP Horizontal Rail Height Spacer
BT8390-WFK1 Ultra-slim Wall Fixing Kit for Mounting Rails
BT8390-WFK2 Wall Fixing Kit for Mounting Rails
BT8390-WFK3 Wall Fixing Kit for Dual Mounting Rails
BT8390-CFK Collar Fixing Kit for Mounting Rails
BT8380-JPK Joining Kit to fix Mounting Rails to Support Columns

INTERFACE ARMS P.24

BT8390-VESA200F VESA 200 Fixed Interface Arms
BT8390-VESA200T VESA 200 Tilting Interface Arms
BT8390-VESA400F VESA 400 Fixed Interface Arms
BT8390-VESA400T VESA 400 Tilting Interface Arms
BT8390-VESA400MAF VESA 400 Arms with Micro-Adjustment
BT8390-VESA400MAP VESA 400 Pop-Out Arms with Micro-Adjustment
BT8390-VESA800F VESA 800 Fixed Interface Arms
BT8390-VESA1200F VESA 1200 Fixed Interface Arms

POLES, CEILING MOUNTS AND COLLARS P.26

BT7850 Ø50mm Poles
BT7853 Heavy Duty Ø50mm Poles
BT7822 Heavy Duty Floor / Ceiling Mount for Ø50mm Poles
BT7807 Heavy Duty Floor / Ceiling Mount for Twin Ø50mm Poles
BT7808 Ceiling / Wall Mount with Tilt for Ø50mm Poles
BT7851 Ø50mm Telescopic Ceiling Mount
BT7831 Wall Mounting bracket for Ø50mm Poles
BT7841 2-Piece Accessory Collar for Ø50mm Poles
BT7051 Heavy Duty Accessory Collar for Ø50mm Poles

HOW-TO-GUIDES P.28-35



SMALL SCREEN INSTALLATIONS

FLAT SCREEN MOUNTS FOR SMALL SCREEN INSTALLS P.36

BT7510 Ultra-slim Fixed Flat Screen Mount for VESA 100 Screens
BT7511 Tilting Flat Screen Mount for VESA 100 Screens
BT7518 Tilt and Swivel Flat Screen Mount for VESA 100 Screens
BT7521 Ultra-slim Fixed Flat Screen Mount for VESA 200 x 100 Screens
BT7522 Tilting Flat Screen Mount for VESA 200 x 100 Screens
BT7524 Tilt and Swivel Flat Screen Mount for VESA 200 x 100 Screens

ACCESSORISE YOUR SYSTEM X INSTALLATION

SHELVES, MEDIA PLAYER AND SPEAKER MOUNTS P.38

BT8390-SA Shelf Adaptor fixes VC Shelves to Mounting Rails
BT7863 VC Shelf for use with Shelf Adaptor
BT7032 Large Steel AV Accessory Shelf
BT7172 Small Glass AV Accessory Shelf
BT7173 Medium Glass AV Accessory Shelf
BT7174 Large Glass AV Accessory Shelf
BT7860 2nd and 3rd Generation Apple TV Mount
BT7880 4th Generation Apple TV Mount
BT77 Side Clamping Loudspeaker Mounts

SYSTEM X ONLINE CONFIGURATION TOOL P.40

NEW MOUNTING SOLUTIONS FROM B-TECH

SHELVES, MEDIA PLAYER MOUNTS AND SPEAKER MOUNTS P.42

BT8312 Ultra-slim Pop-Out Video Wall Mount
BT6157 Stackable Heavy Duty DLP Projector Mount
BT6165 Stackable Heavy Duty DLP Projector Mount with Tilt
BT8355 Freestanding LED Panel Mount
BT8322 Digital Signage Media Player and Flat Screen Mount
BT8430 Universal Flat Screen Wall Mount with Tilt
BT8431 Universal Flat Screen Wall Mount with Tilt
BT8432 Universal Flat Screen Wall Mount with Tilt
BT7396 Wall Mount for Tablet Enclosures
BT7835 Truss Mount for Ø50mm Poles

OFF-THE-SHELF SYSTEM X KITS FOR VIDEO WALLS & MENU BOARDS

Forming the basis of the range, these standard kits from the System X Range cater for the most common video wall and menu board installations and are available off-the-shelf. All products have a high-end look and come with a range of premium features which make the installation process both quick and easy.

For video walls, the universal design of the range allows a single part code to be used for a wide range of different screens. For example, the **BT8371-2X2 Mobile Video Wall Stand** allows ALL video wall screens from 46" to 60" (the most commonly used video wall screens on the market) to be mounted in a 2x2 configuration - so there's no need to waste time researching screen models and sizes before ordering.

For menu boards, a suitable mounting solution must be ordered according to your requirements. This process is made incredibly easy using the **System X online configuration tool** - simply enter a few details and a suitable kit will be collated from our stock of off-the-shelf components.

The online configuration tool can also be used to specify a video wall requirement that differs slightly to the standard off-the-shelf video wall kits (e.g. 4x2), and then quickly ordered.

To view the tool please visit www.btechavmounts.com/systemx-configurator or you can read a more detailed description about this process on **page 40**.

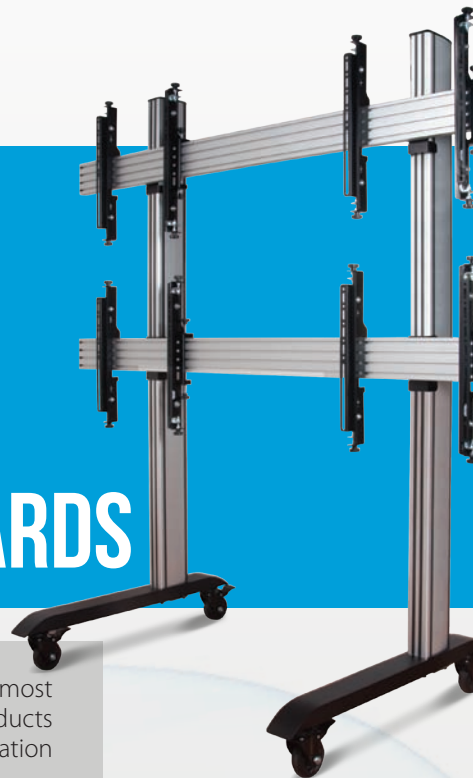

INSTALLS

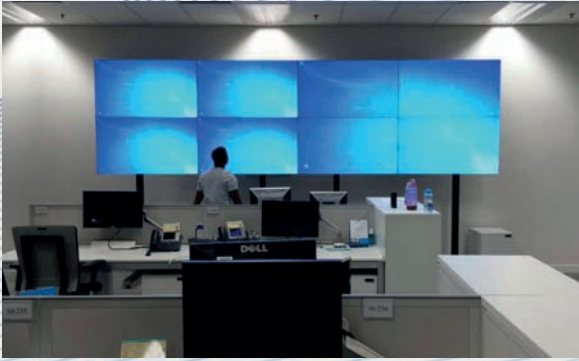



B-TECH AV MOUNTS™

**FITS ALL
SCREENS
46" - 60"**

BT8370-2X2

UNIVERSAL VIDEO WALL STAND FOR 2X2 VIDEO WALLS

Designed to mount video walls in a 2x2 configuration, the BT8370-2x2 is a freestanding mounting solution with a universal design suitable for all video wall screens from 46" to 60". As part of B-Tech's dynamic System X range, this contemporary mounting solution is lightweight yet incredibly strong, has a high-end aesthetic quality and comes with important time saving features such as tool-less 8 point micro-adjustment and a universal screen position spacer to speed up the installation process.

SPECIFICATION

Recommended screen size	46" - 60"
Max load	50kg (per screen)
VESA® & non-VESA fixings	200 x 200 up to 600 x 400
Dimensions	W: 2005mm D: 950mm H: 1898 up to 2094mm
Colour (base & VESA arms)	Black
Colour (verticals)	Black or Silver
Colour (horizontal)	Silver

FEATURES

- Universal design suitable for all video wall screens
- High-end aesthetic quality
- Tool-less micro-adjustments at 8 points for seamless screen alignment
- Integrated cable management
- Includes adjustable levelling feet
- Collar compatible accessories such as shelves can be fitted directly to the extrusion
- Includes re-usable screen position spacer to aid installation of screens
- Safety screws help prevent unauthorised removal of screens
- All mounting hardware included



PER SCREEN

VERTICALS

HORIZONTALS

BASE

ALTERNATE CONFIGURATIONS AVAILABLE



Please see page 40 for more information about our unique online configuration tool designed to create custom installations to suit your own requirements.

Or try it right now at www.btechavmounts.com/systemx-configurator



8 point tool-less micro-adjustment for seamless screen alignment



Cable management covers hide untidy cables and add to the stylish finish



Fit System 2 compatible accessories such as shelves without using collars



Screen spacer designed to eliminate calculations and guess work when installing horizontal rails

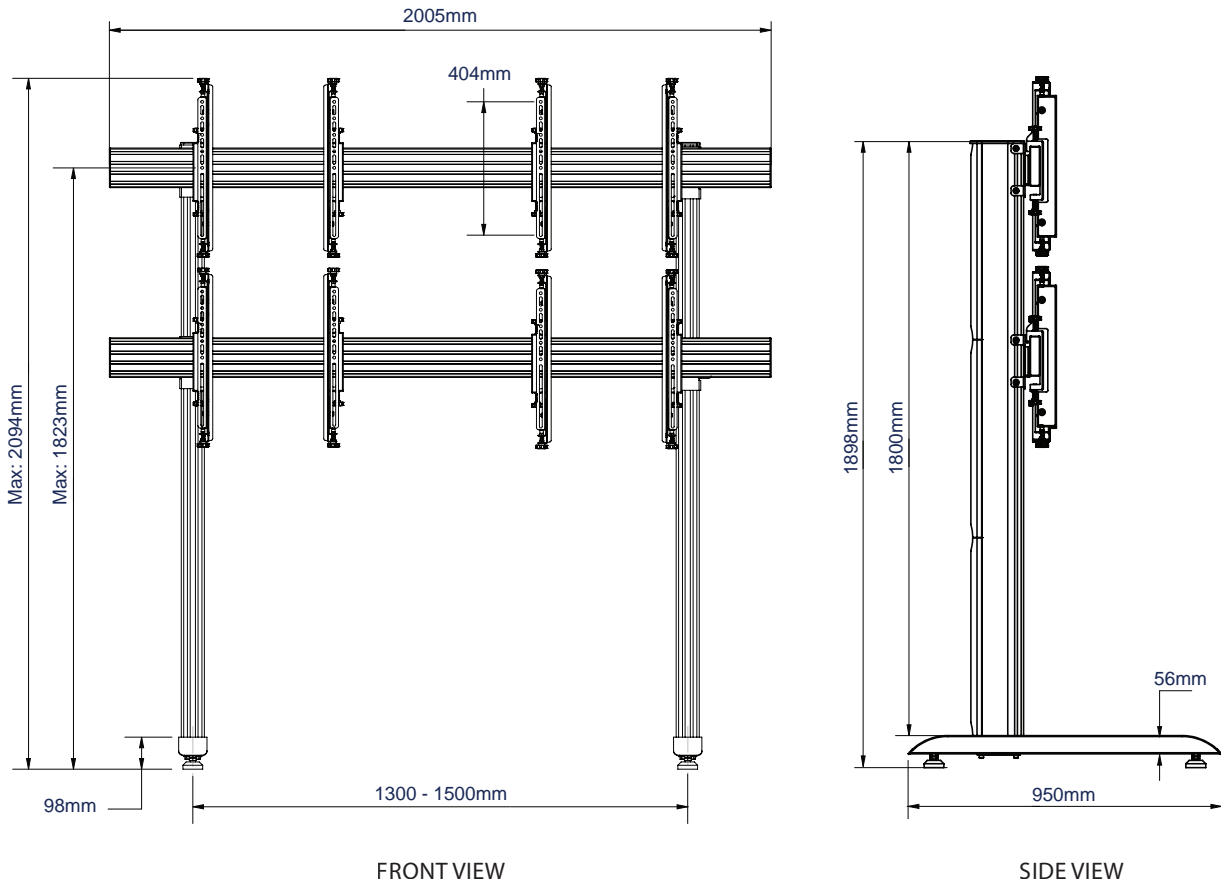

FRONT VIEW

SIDE VIEW

PACKING INFORMATION PLEASE NOTE, THIS IS A 4 BOX ITEM THAT WILL BE PACKED AND DELIVERED ONTO A CUSTOM PALLET. ESTIMATED DIMS: 240 x 100 x 60cm WEIGHT: 107kg

COLOUR:	ORDER REF:	EAN CODE:	MASTER CARTON WEIGHT:	MASTER CARTON CUBE:
Black w/Black Columns	BT8370-2x2/BB	5019318501302	23kg / 17kg / 17kg / 22kg	0.129cbm / 0.103cbm / 0.603cbm / 0.0745cbm
Black w/Silver Columns	BT8370-2x2/BS	5019318501319	23kg / 17kg / 17kg / 22kg	0.129cbm / 0.103cbm / 0.603cbm / 0.0745cbm

RELATED PRODUCTS AND ACCESSORIES



BT8370-3X3
Universal Video Wall Stand
for 3x3 Video Walls



BT8371-2X2
Universal Mobile Video Wall Stand
for 2x2 Video Walls



BT8371-3X3
Universal Mobile Video Wall Stand
for 3x3 Video Walls



BT7172 / BT7173 / BT7174
AV Accessory Shelves can be attached
directly to a vertical column



**FITS ALL
SCREENS
46" - 60"**

BT8370-3X3

UNIVERSAL VIDEO WALL STAND FOR 3X3 VIDEO WALLS

Designed to mount video walls in a 3x3 configuration, the BT8370-3x3 is a freestanding mounting solution for video wall screens and is available in two sizes; one for screens from 46" to 55" and a wider version for 60" screens. As part of B-Tech's dynamic System X range, this contemporary mounting solution is lightweight yet incredibly strong, has a high-end aesthetic quality and comes with important time saving features such as tool-less 8 point micro-adjustment and screen positioning to speed up the installation process.

SPECIFICATION

Recommended screen size	46" - 60"*
Max load	50kg (per screen)
VESA® & non-VESA fixings	200 x 200 up to 600 x 400
Dimensions	W: 3005mm* D: 950mm H: 2498 up to 2699mm
Colour (base & VESA arms)	Black
Colour (verticals)	Black or Silver
Colour (horizontals)	Silver

*Please note **BT8370-3X3** is available in two packages:
BT8370-3X3 is designed for screens from 46"-55" and **BT8370-3X3-60** is designed for screens from 55"-60"
BT8370-3X3-60 has a width of 3505mm

FEATURES

- Universal design suitable for all video wall screens
- High-end aesthetic quality
- Tool-less micro-adjustments at 8 points for seamless screen alignment
- Integrated cable management
- Includes adjustable levelling feet
- Collar compatible accessories such as shelves can be fitted directly to the extrusion
- Includes re-usable screen position spacer to aid installation of screens
- Safety screws help prevent unauthorised removal of screens
- All mounting hardware included



PER SCREEN

VERTICALS

HORIZONTALS

BASE

ALTERNATE CONFIGURATIONS AVAILABLE



Please see page 40 for more information about our unique online configuration tool designed to create custom installations to suit your own requirements.

Try it now at www.btechavmounts.com/systemx-configurator



8 point tool-less micro-adjustment for seamless screen alignment



Cable management covers hide untidy cables and add to the stylish finish



Fit System 2 compatible accessories such as shelves without using collars



Screen spacer designed to eliminate calculations and guess work when installing horizontal rails

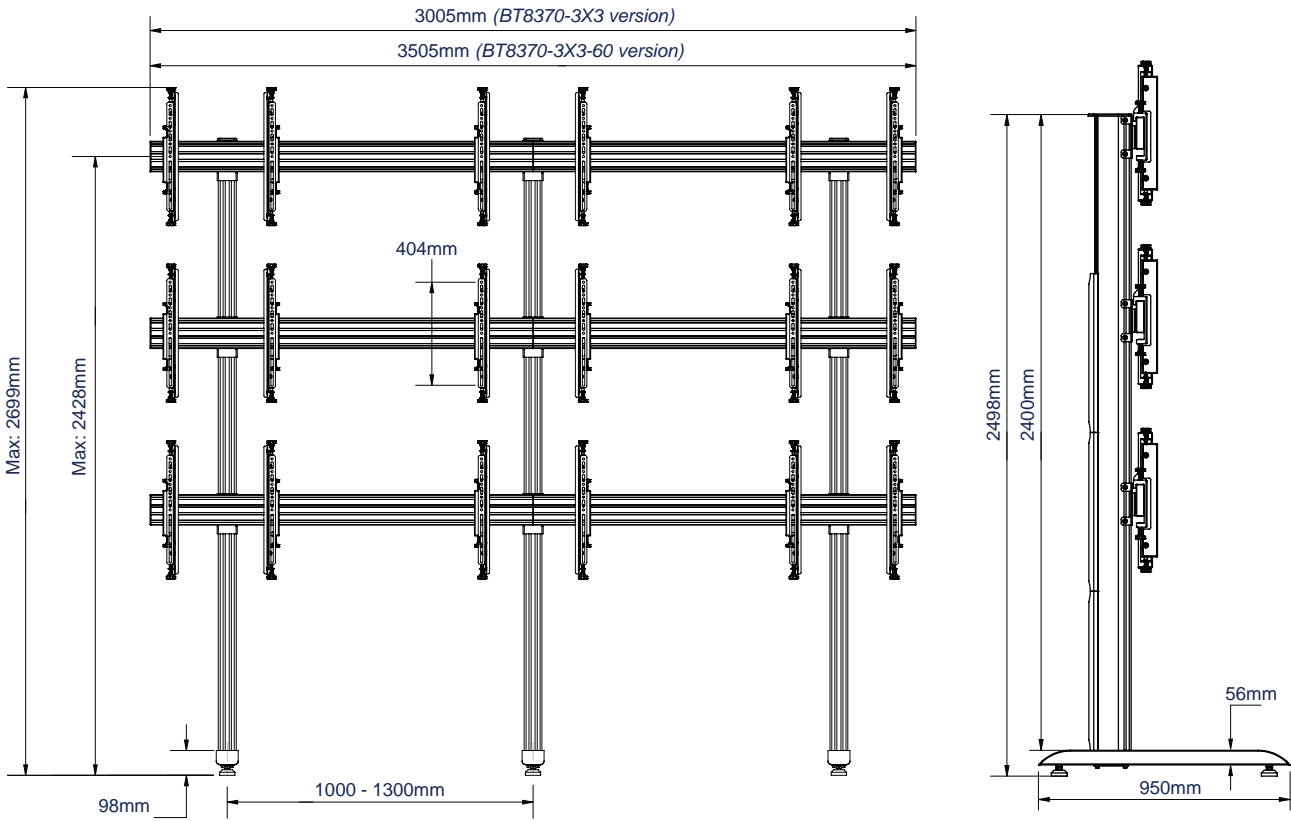

FRONT VIEW

SIDE VIEW

PACKING INFORMATION

PLEASE NOTE, THIS IS A 9 BOX ITEM THAT WILL BE PACKED AND DELIVERED ONTO A CUSTOM PALLET. ESTIMATED DIMS: 240x100x60cm WEIGHT: 189kg

COLOUR:	ORDER REF:	EAN CODE:	MASTER CARTON WEIGHT:	MASTER CARTON CUBE:
Black w/Black Columns	BT8370-3x3/BB	5019318501302	x3 15kg / x2 18kg / 1x 16kg 1x 8kg 1x 24kg / 1x 25kg	x3 0.083cbm / x2 0.103cbm / 1x 0.060cbm / 1x 0.025cbm 1x 0.054cbm / 1x 0.704cbm
Black w/Silver Columns	BT8370-3x3/BS	5019318501319	x3 15kg / x2 18kg / 1x 16kg 1x 8kg 1x 24kg / 1x 25kg	x3 0.083cbm / x2 0.103cbm / 1x 0.060cbm / 1x 0.025cbm 1x 0.054cbm / 1x 0.704 cbm
Black w/Black Columns	BT8370-3x3-60/BB	5019318501340	x3 15kg / x2 21kg / 2x 16kg 1x 15kg / 1x 25kg	x3 0.083cbm / x2 0.141cbm / 1x 0.060cbm / 1x 0.025cbm 1x 0.054cbm / 1x 0.704cbm
Black w/Silver Columns	BT8370-3x3-60/BS	5019318501357	x3 15kg / x2 21kg / 2x 16kg 1x 15kg / 1x 25kg	x3 0.083cbm / x2 0.141cbm / 1x 0.060cbm / 1x 0.025cbm 1x 0.054cbm / 1x 0.704cbm

RELATED PRODUCTS AND ACCESSORIES

<p>BT8370-2X2</p>	<p>BT8371-2X2</p>	<p>BT8371-3X3</p>	<p>BT7172 / BT7173 / BT7174</p>
<p>Universal Video Wall Stand for 3x3 Video Walls</p>	<p>Universal Mobile Video Wall Stand for 2x2 Video Walls</p>	<p>Universal Mobile Video Wall Stand for 3x3 Video Walls</p>	<p>AV Accessory Shelves can be attached directly to a vertical column</p>



**FITS ALL
SCREENS
46" - 60"**

BT8371-2X2

UNIVERSAL MOBILE VIDEO WALL STAND FOR 2X2 VIDEO WALLS

Designed to mount video walls in a 2x2 configuration, the BT8371-2x2 is a mobile mounting solution with a universal design suitable for all video wall screens from 46" to 60". As part of B-Tech's dynamic System X range, this contemporary mounting solution is lightweight yet incredibly strong, has a high-end aesthetic quality and comes with important time saving features such as tool-less 8 point micro-adjustment and a universal screen position spacer to speed up the installation process.

SPECIFICATION

Recommended screen size	46" - 60"
Max load	50kg (per screen)
VESA® & non-VESA fixings	200 x 200 up to 600 x 400
Dimensions	W: 2005mm D: 950mm H: 1992 up to 2193mm
Colour (base & VESA arms)	Black
Colour (verticals)	Black or Silver
Colour (horizontal)	Silver

FEATURES

- Universal design suitable for all video wall screens
- High-end aesthetic quality
- Tool-less micro-adjustments at 8 points for seamless screen alignment
- Integrated cable management
- Includes non-marking 4" locking/braked castors and alternative levelling feet
- Collar compatible accessories such as shelves can be fitted directly to the extrusion
- Includes re-usable screen position spacer to aid installation of screens
- Safety screws help prevent unauthorised removal of screens
- All mounting hardware included



PER SCREEN

VERTICALS

HORIZONTALS

BASE

ALTERNATE CONFIGURATIONS AVAILABLE



Please see page 40 for more information about our unique online configuration tool designed to create custom installations to suit your own requirements.

Try it now at www.btechavmounts.com/systemx-configurator



8 point tool-less micro-adjustment for seamless screen alignment



Cable management covers hide untidy cables and add to the stylish finish



Fit System 2 compatible accessories such as shelves without using collars



Screen spacer designed to eliminate calculations and guess work when installing horizontal rails

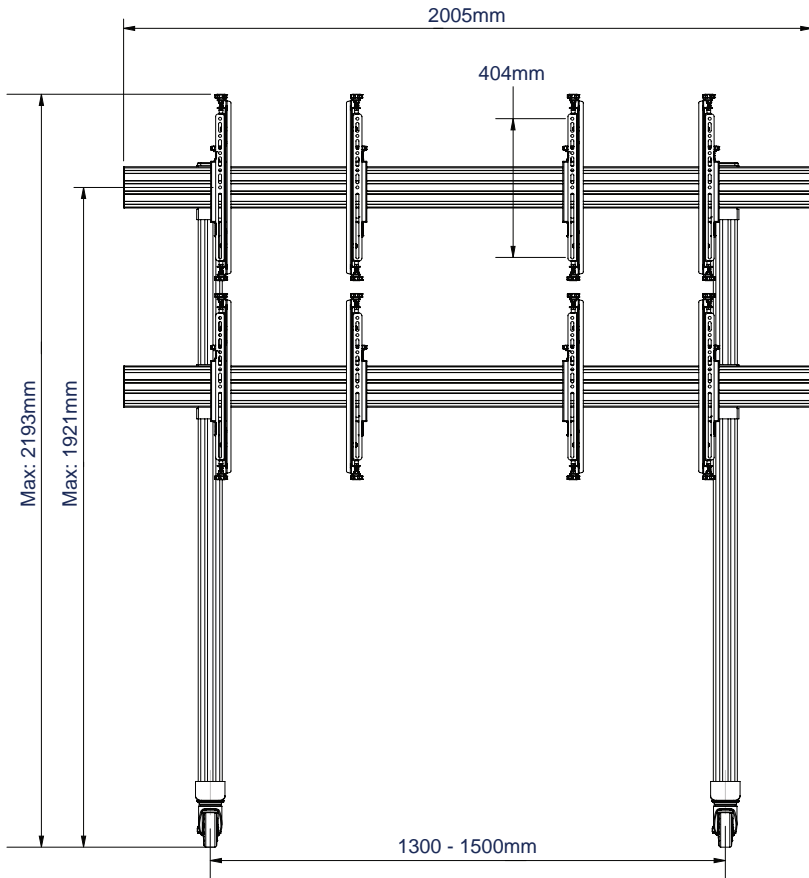

FRONT VIEW

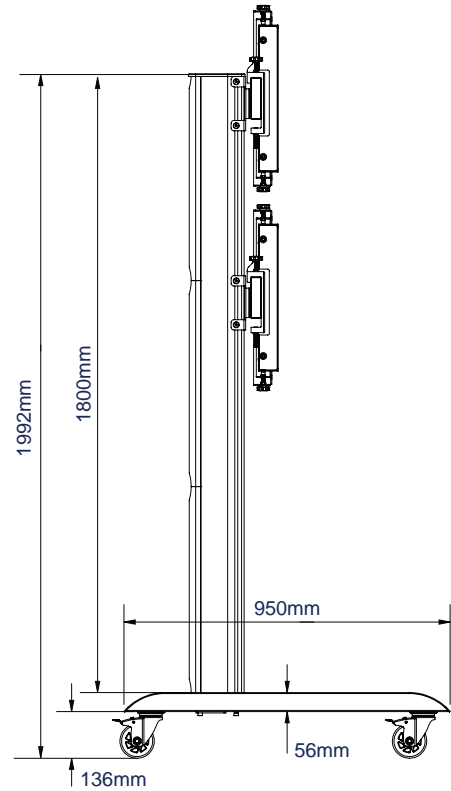

SIDE VIEW

PACKING INFORMATION PLEASE NOTE, THIS IS A 4 BOX ITEM THAT WILL BE PACKED AND DELIVERED ONTO A CUSTOM PALLET. ESTIMATED DIMS: 240x 100x 60cm WEIGHT: 112kg

COLOUR:	ORDER REF:	EAN CODE:	MASTER CARTON WEIGHT:	MASTER CARTON CUBE:
Black w/Black Columns	BT8371-2x2/BB	5019318501364	23kg / 17kg / 17kg / 27kg	0.129cbm / 0.103cbm / 0.603cbm / 0.0864cbm
Black w/Silver Columns	BT8371-2x2/BS	5019318501371	23kg / 17kg / 17kg / 27kg	0.129cbm / 0.103cbm / 0.603cbm / 0.0864cbm

RELATED PRODUCTS AND ACCESSORIES



BT8371-3X3
Universal Mobile Video Wall Stand for 3x3 Video Walls



BT8370-2X2
Universal Video Wall Stand for 2x2 Video Walls



BT8370-3X3
Universal Mobile Video Wall Stand for 3x3 Video Walls



BT7172 / BT7173 / BT7174
AV Accessory Shelves can be attached directly to a vertical column



**FITS ALL
SCREENS
46" - 60"**

BT8371-3X3

UNIVERSAL MOBILE VIDEO WALL STAND FOR 3X3 VIDEO WALLS

Designed to mount video walls in a 3x3 configuration, the BT8371-3x3 is a mobile mounting solution for video wall screens and is available in two sizes; one for screens from 46" to 55" and a wider version for 60" screens. As part of B-Tech's dynamic System X range, this contemporary mounting solution is lightweight yet incredibly strong, has a high-end aesthetic quality and comes with important time saving features such as tool-less 8 point micro-adjustment and screen positioning to speed up the installation process.

SPECIFICATION

Recommended screen size	46" - 60"*
Max load	50kg (per screen)
VESA® & non-VESA fixings	200 x 200 up to 600 x 400
Dimensions	W: 3005mm* D: 950mm H: 2592 up to 2793mm
Colour (base & VESA arms)	Black
Colour (verticals)	Black or Silver
Colour (horizontals)	Silver

*Please note BT8371-3X3 is available in two packages:

BT8371-3X3 is designed for screens from 46"-55" and BT8371-3X3-60 is designed for screens from 55"-60"

*BT8371-3X3-60 has a width of 3505mm

FEATURES

- Universal design suitable for all video wall screens
- High-end aesthetic quality
- Tool-less micro-adjustments at 8 points for seamless screen alignment
- Integrated cable management
- Includes non-marking 4" locking/braked castors and alternative levelling feet
- Collar compatible accessories such as shelves can be fitted directly to the extrusion
- Includes re-usable screen position spacer to aid installation of screens
- Safety screws help prevent unauthorised removal of screens
- All mounting hardware included



PER SCREEN

VERTICALS

HORIZONTALS

BASE

ALTERNATE CONFIGURATIONS AVAILABLE



Please see page 40 for more information about our unique online configuration tool designed to create custom installations to suit your own requirements.

Try it now at www.btechavmounts.com/systemx-configurator



8 point tool-less micro-adjustment for seamless screen alignment



Cable management covers hide untidy cables and add to the stylish finish



Fit System 2 compatible accessories such as shelves without using collars



Screen spacer designed to eliminate calculations and guess work when installing horizontal rails

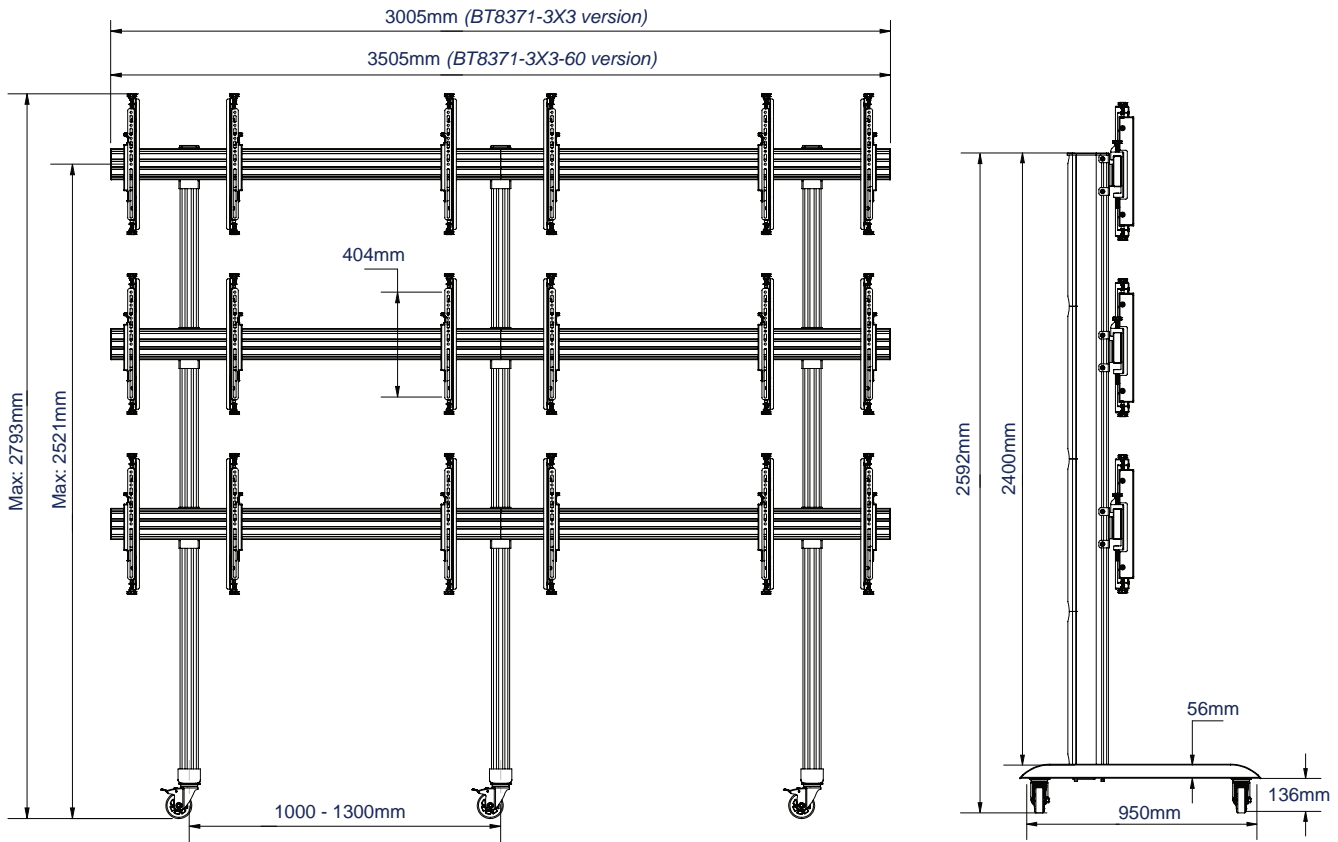

FRONT VIEW

SIDE VIEW

PACKING INFORMATION

PLEASE NOTE, THIS IS A 9 BOX ITEM THAT WILL BE PACKED AND DELIVERED ONTO A CUSTOM PALLET. ESTIMATED DIMS: 240x100x60cm WEIGHT: 180kg

COLOUR:	ORDER REF:	EAN CODE:	MASTER CARTON WEIGHT:	MASTER CARTON CUBE:
Black w/Black Columns	BT8371-3x3/BB	5019318501388	x3 15kg / x2 18kg / 2x 16kg 1x 8kg 1x 24kg / 1x 25kg	x3 0.083cbm / x2 0.103cbm / 1x 0.060cbm / 1x 0.025cbm 1x 0.054cbm / 1x 0.704cbm
Black w/Silver Columns	BT8371-3x3/BS	5019318501395	x3 15kg / x2 18kg / 1x 16kg 1x 8kg 1x 24kg / 1x 25kg	x3 0.083cbm / x2 0.103cbm / 1x 0.060cbm / 1x 0.025cbm 1x 0.054cbm / 1x 0.704cbm
Black w/Black Columns	BT8371-3x3-60/BB	5019318501401	x3 15kg / x2 21kg / 1x 16kg 1x 8kg 1x 15kg / 1x 25kg	x3 0.083cbm / x2 0.141cbm / 1x 0.060cbm / 1x 0.025cbm 1x 0.054cbm / 1x 0.704cbm
Black w/Silver Columns	BT8371-3x3-60/BS	5019318501418	x3 15kg / x2 21kg / 1x 16kg 1x 8kg 1x 15kg / 1x 25kg	x3 0.083cbm / x2 0.141cbm / 1x 0.060cbm / 1x 0.025cbm 1x 0.054cbm / 1x 0.704cbm

RELATED PRODUCTS AND ACCESSORIES

<p>BT8371-2X2</p>	<p>BT8370-3X3</p>	<p>BT8370-2X2</p>	<p>BT7172 / BT7173 / BT7174</p>
<p>Universal Mobile Video Wall Stand for 2x2 Video Walls</p>	<p>Universal Video Wall Stand for 3x3 Video Walls</p>	<p>Universal Video Wall Stand for 2x2 Video Walls</p>	<p>AV Accessory Shelves can be attached directly to a vertical column</p>



B-TECH AV MOUNTS™

BT8330

UNIVERSAL MENU BOARD MOUNTING SYSTEM

WALL
OR POLE
MOUNTED



The BT8330 is a modular mounting system designed for menu board installations of any length. As part of the new System X Range, the BT8330 can be used in thousands of different configurations and must be ordered according to your requirements. This process is made easy using B-Tech's online configuration tool - simply visit www.btechavmounts.com/systemx-configurator and enter a few details (such as number of screens and their size) and the configurator will select all of the components needed and create a single part code with which to place your order.

SPECIFICATION

Recommended screen size	32" - 65"
Max load	50kg (per screen)
VESA® & non-VESA fixings	200 x 200 up to 800 x 400*
Tilting option	+20°
Colour (VESA arms)	Black
Colour (horizontal rail)	Silver

*Please note screens with VESA patterns larger than 400 x 400 need to use additional adaptors (BT7564) when used in portrait mode, these are available separately.

FEATURES

- Universal design suitable for all sized screens up to 50kg (per screen)
- High-end aesthetic quality
- Can be used in a variety of configurations
- Wall or ceiling mounted options available
- Suitable for landscape or portrait screen mounting
- Multiple rail lengths available (rails can also be joined)
- Available with a choice of fixed, tilting or micro-adjustment arms
- All arms feature levelling screws to adjust the screen height
- Tilt arms feature up to +20° tilt
- Micro-adjustment arms allow screen depth to be adjusted at each corner
- Safety screws help prevent unauthorised removal of screens



PER SCREEN WITH TILT ARMS

MINIMUM

MINIMUM

RAILS

ARMS

CREATE YOUR MOUNTING SYSTEM ONLINE

SPECIFY YOUR REQUIREMENTS ONLINE AND OUR CONFIGURATION TOOL WILL CREATE A BT8330 KIT TO SUIT YOUR EXACT NEEDS



Video wall and menu board installations can vary dramatically from one install to the next, so the BT8330 has been designed on a modular principle with over 2000 different configurations available! Please see page 40 for information about our unique online configuration tool designed to create custom installations to suit your own requirements.

Try it now at www.btechavmounts.com/systemx-configurator



Premium finish gives a contemporary, high-end aesthetic quality



Tilt arms feature +20° tilt adjustment



A choice of interface arms are available: VESA 200 fixed, VESA 200 tilt, VESA 400 fixed, VESA 400 tilt and VESA 400 with micro-adjustment



Rails are available in 0.7m, 1.5m, 1.75m and 2m lengths but can also be joined together.

VESA 200 INTERFACE ARMS AVAILABLE

BT8390-VESA200F
FIXED VESA 200 ARMS

BT8390-VESA200T
VESA 200 ARMS WITH TILT

WALL FIXING KITS AVAILABLE

BT8390-WFK1
USE WITH FIXED AND TILT ARMS

BT8390-WFK2
USE WITH MICRO-ADJUSTMENT ARMS

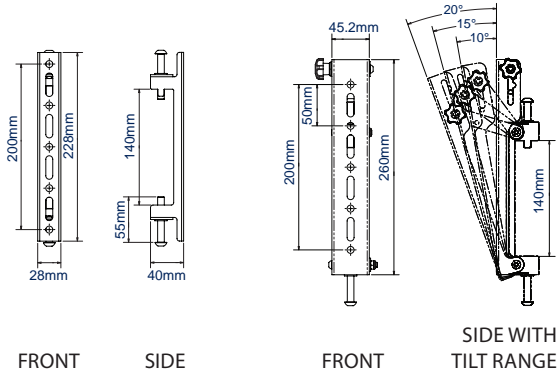

FRONT

SIDE

FRONT

SIDE WITH TILT RANGE

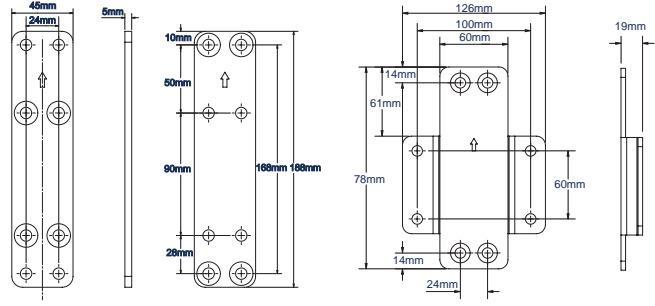

FRONT

SIDE

BACK

FRONT

SIDE

VESA 400 INTERFACE ARMS AVAILABLE

BT8390-VESA400F
FIXED VESA 400 ARMS

BT8390-VESA400T
VESA 400 ARMS WITH TILT

BT8390-VESA400MAF
FIXED VESA 400 ARMS WITH MICRO-ADJUSTMENT

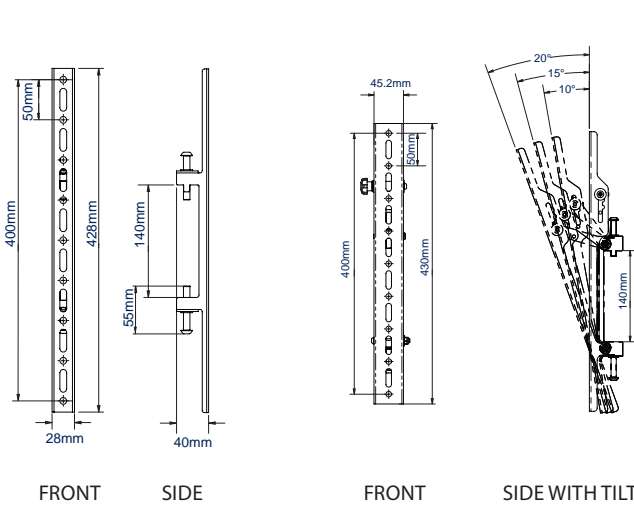

FRONT

SIDE

FRONT

SIDE WITH TILT RANGE

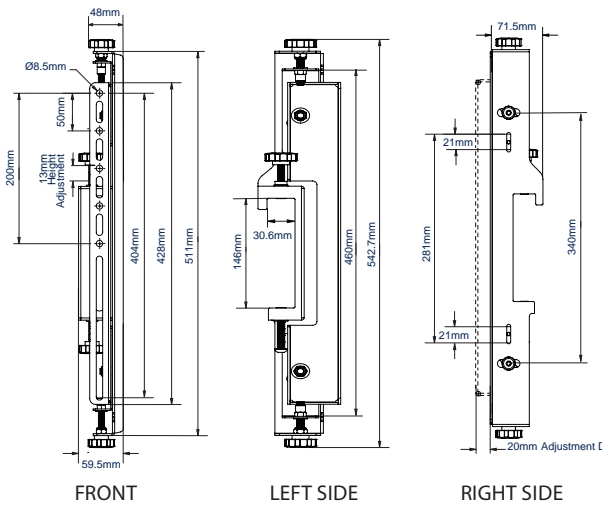

FRONT

LEFT SIDE

RIGHT SIDE

MOUNTING RAILS AVAILABLE

BT8390-070
0.7M

BT8390-150
1.5M

BT8390-175
1.75M

BT8390-200
2M

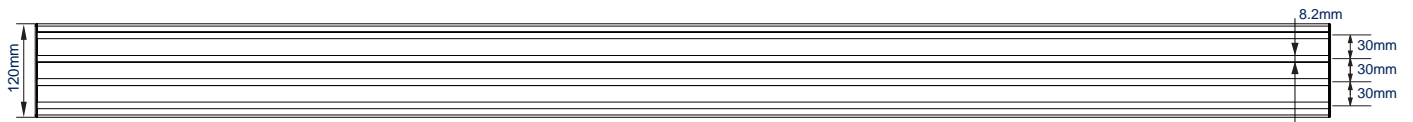

RELATED PRODUCTS AND ACCESSORIES

BT8340



Universal Mounting System
for video walls and menu boards
with multiple rows

BT7822



Heavy Duty Ceiling Mount included
with all ceiling mounted BT8330 kits

BT7850



Ø50mm Poles included with all
ceiling mounted BT8330 kits

BT7051



Heavy Duty Accessory Collar included
with all ceiling mounted BT8330 kits



B-TECH AV MOUNTS™

WALL
OR POLE
MOUNTED

BT8340

UNIVERSAL VIDEO WALL MOUNTING SYSTEM

The BT8340 is a modular mounting system designed for video walls and multiple row menu board installations of any length. As part of the new System X Range, the BT8340 can be used in thousands of different configurations and must be ordered according to your requirements. This process is made easy using B-Tech's online configuration tool - simply visit www.btechavmounts.com/systemx-configurator and enter a few details (such as number of screens and their size) and the configurator will select all of the components needed and create a single part code with which to place your order.

SPECIFICATION

Recommended screen size	32" - 65"
Max load	50kg (per screen)
VESA® & non-VESA fixings	200 x 200 up to 800 x 400*
Tilting option	+20°
Colour (VESA arms)	Black
Colour (horizontal rail)	Silver

*Please note screens with VESA patterns larger than 400 x 400 need to use additional adaptors (BT7564) when used in portrait mode, these are available separately.

FEATURES

- Universal design suitable for all sized screens up to 50kg (per screen)
- High-end aesthetic quality
- Can be used in a variety of configurations
- Wall or ceiling mounted options available
- Suitable for landscape or portrait screen mounting
- Multiple rail lengths available (rails can also be joined)
- Available with a choice of fixed, tilting or micro-adjustment arms
- All arms feature levelling screws to adjust the screen height
- Tilt arms feature up to +20° tilt
- Micro-adjustment arms allow screen depth to be adjusted at each corner
- Safety screws help prevent unauthorised removal of screens



PER SCREEN WITH TILT ARMS

MINIMUM MINIMUM RAILS ARMS

CREATE YOUR MOUNTING SYSTEM ONLINE

SPECIFY YOUR REQUIREMENTS ONLINE AND OUR CONFIGURATION TOOL WILL CREATE A BT8340 KIT TO SUIT YOUR EXACT NEEDS



Video wall and menu board installations can vary dramatically from one install to the next, so the BT8340 has been designed on a modular principle with over 2000 different configurations available! Please see page 40 for information about our unique online configuration tool designed to create custom installations to suit your own requirements.

Try it now at www.btechavmounts.com/systemx-configurator



Premium finish gives a contemporary, high-end aesthetic quality

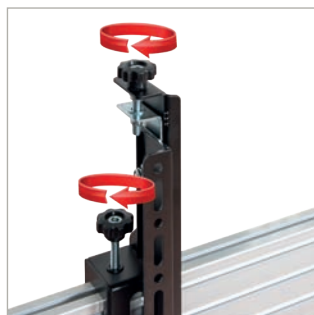

Micro-adjustment arms feature tool-less height and depth adjustment knobs



A choice of interface arms are available: VESA 200 fixed, VESA 200 tilt, VESA 400 fixed, VESA 400 tilt and VESA 400 with micro-adjustment



Rails are available in 0.7m, 1.5m, 1.75m and 2m lengths but can also be joined together.

WALL FIXING KITS AVAILABLE

BT8390-WFK1
USE WITH FIXED ARMS

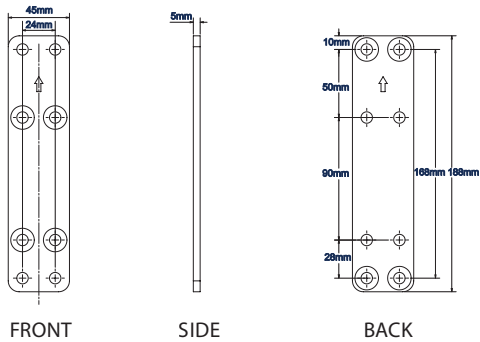

BT8390-WFK2
USE WITH MICRO-ADJUSTMENT ARMS

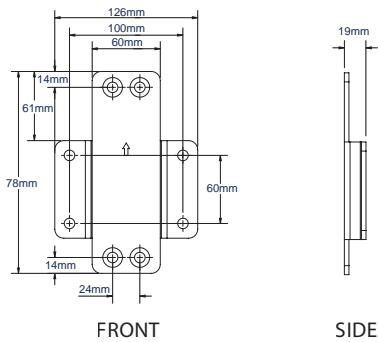

VESA INTERFACE ARMS AVAILABLE

BT8390-VESA200F
FIXED VESA 200 ARMS

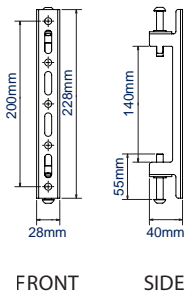

BT8390-VESA400F
FIXED VESA 400 ARMS

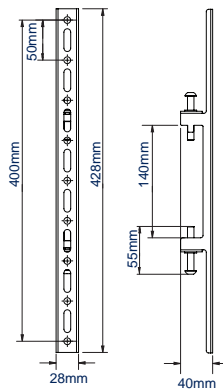

BT8390-VESA400MAF
FIXED VESA 400 ARMS WITH MICRO-ADJUSTMENT

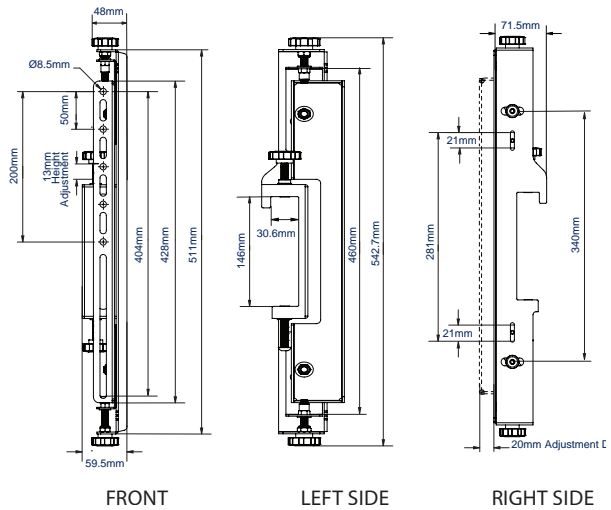

MOUNTING RAILS AVAILABLE

BT8390-070
0.7M

BT8390-150
1.5M

BT8390-175
1.75M

BT8390-200
2M

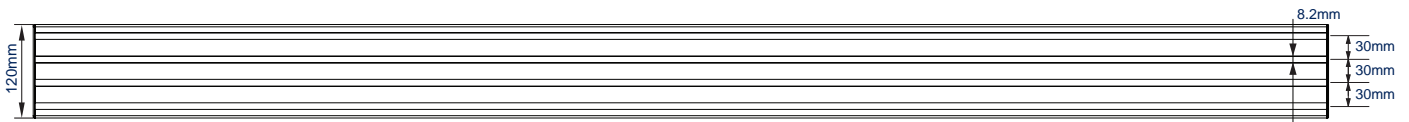

RELATED PRODUCTS AND ACCESSORIES

BT8330

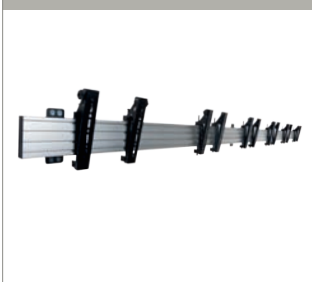

Universal Menu Board Mounting System for menu board installations of any length

BT7822



Heavy Duty Ceiling Mount included with all ceiling mounted BT8340 kits

BT7850



Ø50mm Poles included with all ceiling mounted BT8340 kits

BT7051



Heavy Duty Accessory Collar included with all ceiling mounted BT8340 kits

SYSTEM X COMPONENTS FOR STANDARD OR CUSTOM INSTALLATIONS



The System X Range consists of a highly comprehensive collection of components and it is from these individual parts that the off-the-shelf kits are made. These versatile components can also be ordered individually to create bespoke video wall, menu board and other multi-screen mounting solutions according to your requirements.

Since the range first launched, additional components have been introduced - significantly increasing the number of ways the system can be used and, when integrated with B-Tech's other professional ranges (such as System 2 ceiling mounts and poles) the possibilities are almost endless!

Ordering components instead of kits has two main benefits; complex mounting solutions can be created for configurations which aren't catered for by the standard packages and, quantities of different components can be held in stock, allowing you to quickly fulfil customer orders no matter what their requirement may be.

There are a variety of different types of components available; fixed, freestanding or mobile bases, vertical support columns, horizontal mounting rails and a variety of different screen interface arms ranging from fixed to pop-out. Installations can even be accessorised with a variety of other equipment such as AV shelves or smaller flat screens.

The following pages list the individual System X components and other compatible B-Tech Professional products, along with guides which explain how some of the components are used in order to create a complete mounting solution.



INSTALLS

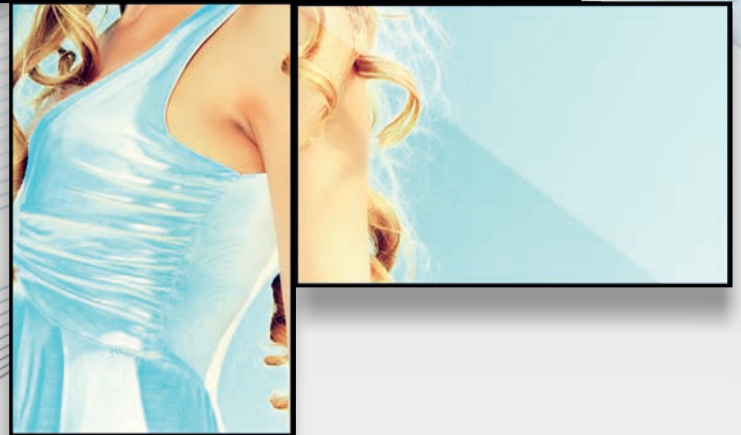
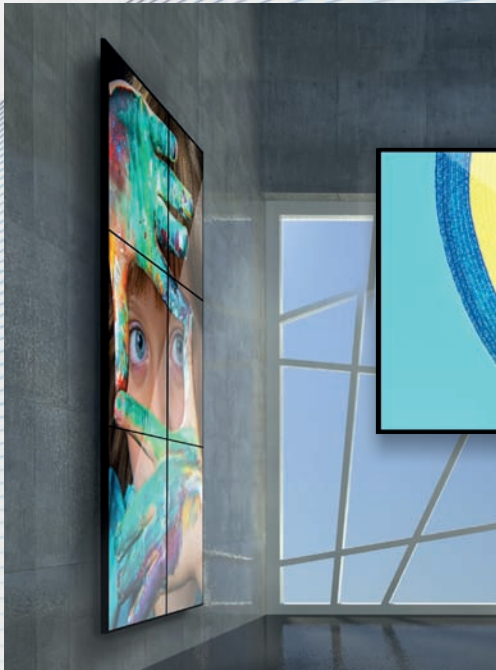

INDIVIDUAL COMPONENTS

VERTICAL COLUMNS & BASES

A variety of different floor bases are available depending what type of install is required; freestanding, fixed or mobile. Vertical columns are then fixed to these bases and come in a variety of different lengths - with the ability to join columns together using the new column coupler.

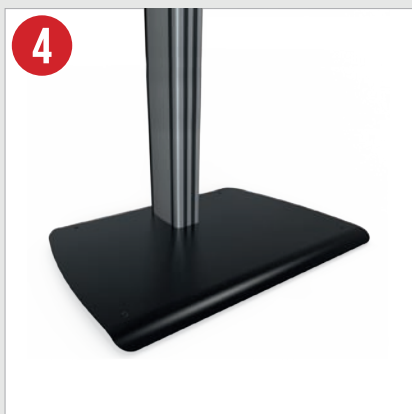
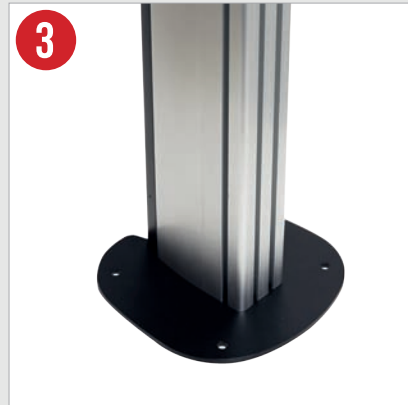

PRODUCT LIST



For more information about all other B-Tech products please scan the QR code below or visit www.btechavmounts.com alternatively, you can contact us at **(+44) 1327 300787** or info@btechavmounts.co.uk



1

BT8380

VERTICAL SUPPORT COLUMNS

BT8380 columns fix to a variety of different bases to form the central core of Trolley and Floor stand installations. Available in 4 different lengths; **BT8380-60** (60cm), **BT8380-120** (120cm), **BT8380-180** (180cm) and **BT8380-240** (240cm) all columns are available in silver or black and come with cable management covers and plastic trim strips for a neat, professional finish.

2

BT8380-CPL

VERTICAL SUPPORT COLUMN COUPLER

Coupler allows two BT8380 columns to be joined together securely. Available in black.

3

BT8380-FFB

FIXED FLOOR BASE

This bolt down base allows BT8380 columns to be bolted to the floor to create a secure installation with a small, discreet footprint. Available in black.

4

BT8380-BASEM

FREESTANDING FLOOR BASE - MEDIUM

This medium sized floor base for BT8380 columns allows freestanding single or multi-screen installations without the need to permanently fix to the floor. Available in black.

5

BT8380-BASEL

FREESTANDING FLOOR BASE - LARGE

This large sized floor base for BT8380 columns allows freestanding single or multi-screen installations without the need to permanently fix to the floor. Available in black.

6

BT8380-BASE

TROLLEY / FLOOR STAND BASE

This base for BT8380 columns comes with height adjustable levelling feet for use as a floor stand but can also be used with castors (available separately) to create a mobile mounting solution. When using the BT8380-BASE at least two must be used together. Available in black.

7

BT8380-CASTOR

4" BRAKED CASTORS

These braked castors simply screw into the BT8380-BASE (available separately) to create a mobile mounting solution. Available in black.

8

BT8380-FBFK

FLOOR BASE FIXING KIT

Allows a BT8380-BASE to be bolted to the floor for added security or to prevent unwanted movement of the finished installation. Available in black.

INDIVIDUAL COMPONENTS

HORIZONTAL RAILS & FIXING KITS

Horizontal Mounting Rails provide the basis for all System X installations and are therefore an essential part of all configurations. Available in a variety of different lengths, extension kits can be used to join rails together as many times as necessary to increase the overall length. Rails can be fixed onto Vertical Columns, to System 2 Ø50mm poles or directly to walls using a range of different fixing kits based on the application.

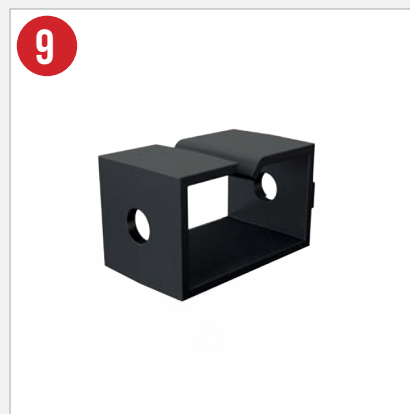
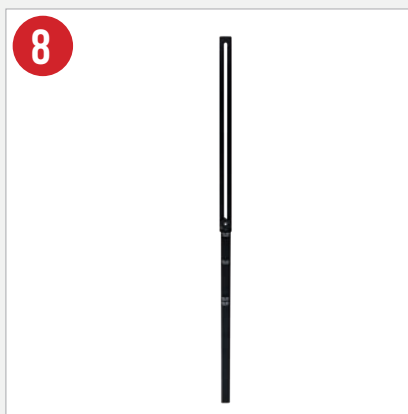
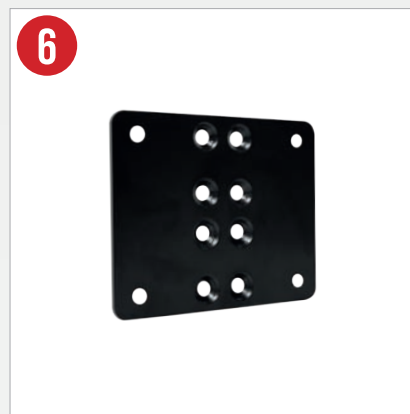
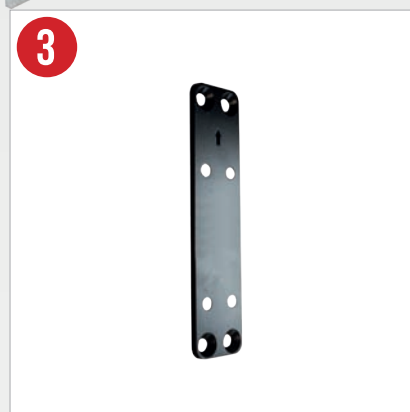
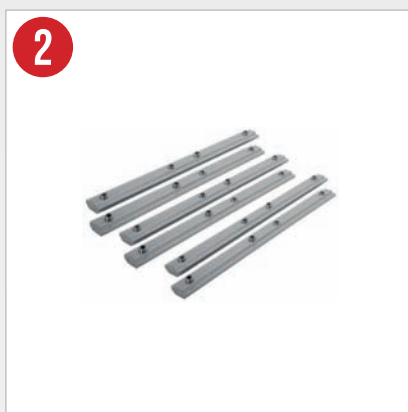

PRODUCT LIST



For more information about all other B-Tech products please scan the QR code below or visit www.btechavmounts.com alternatively, you can contact us at **(+44) 1327 300787** or info@btechavmounts.co.uk



1

BT8390

HORIZONTAL MOUNTING RAILS

BT8390 rails are essential to all System X installations - fixing directly onto walls or onto vertical support columns or Ø50mm poles using the relevant fixing kit. Available in 4 different lengths; **BT8390-70** (70cm), **BT8390-150** (150cm), **BT8390-175** (175cm) and **BT8390-200** (200cm) all rails are available in silver and come with plastic end caps for a neat, professional finish.

2

BT8390-EXT

MOUNTING RAIL EXTENSION KIT

Extension kit allows BT8390 rails to be joined together securely to extend rail lengths as long as necessary. Available in silver.

3

BT8390-WFK1

MOUNTING RAIL WALL FIXING KIT - ULTRA-SLIM

This wall fixing kit allows BT8390 mounting rails to be fixed directly to a wall and, at a depth of just 5mm is ideal for close to the wall installations such as single row menu boards on fixed or tilting interface arms. Available in black.

4

BT8390-WFK2

MOUNTING RAIL WALL FIXING KIT

This wall fixing kit allows BT8390 mounting rails to be fixed directly to a wall and, at a depth of 19mm is ideal for multiple row video wall installations when a greater tilt angle or larger, more advanced interface arms (such as those with micro-adjustment) are required. Available in black.

5

BT8390-WFK3

DUAL MOUNTING RAIL WALL FIXING KIT

This wall fixing kit allows two BT8390 mounting rails to be fixed directly to a wall or vertical support column and is designed for XL screen installations using VESA 800 or VESA 1200 System X interface arms. Available in black.

6

BT8390-CFK

MOUNTING RAIL COLLAR FIXING KIT

This collar fixing kit allows BT8390 mounting rails to be fixed to B-Tech accessory collars for use in pole mounted installations. Available in black.

7

BT8380-JPK

JOINING PLATE KIT

This joining kit allows BT8390 mounting rails to be fixed directly onto BT8380 vertical support columns for trolley and floor stand installations. Available in black.

8

BT8390-SP

SCREEN SPACER

This screen spacer is designed to speed up the installation process of trolley and floor stand installations and comes with pre-set screen size indicators for all common video wall screen sizes. Available in black.

9

BT8390-CMC

CABLE MANAGEMENT CLIP

Designed to attach to BT8390 mounting rails, this discreet cable management clip helps to keep cables organised for a neat and tidy installation. Available in black.

INDIVIDUAL COMPONENTS

SCREEN INTERFACE ARMS

Interface arms fit directly to the rear of screens and can then be quickly hooked onto Horizontal Mounting Rails. Available in a variety of different sizes, each arm has been carefully designed for a specific job - with features ranging from tilt, 8-point micro-adjustment and a pop-in, pop-out mechanism, it's easy to find an interface arm to suit your exact needs.



1



2



3



4



5



6



7



8



9



PRODUCT LIST



For more information about all other B-Tech products please scan the QR code below or visit www.btechavmounts.com alternatively, you can contact us at **(+44) 1327 300787** or info@btechavmounts.co.uk

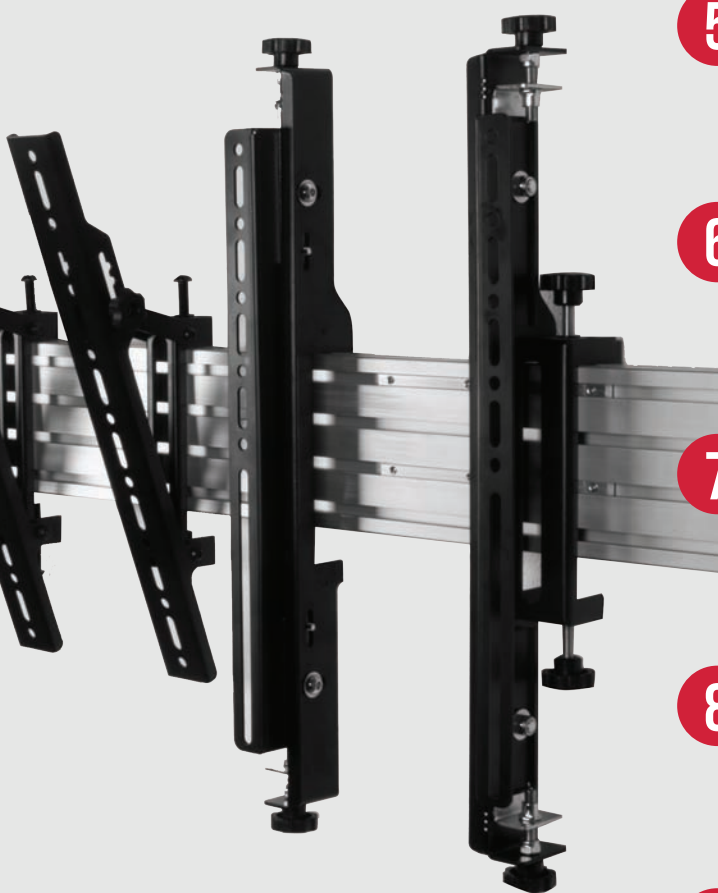

1

BT8390-VESA200F

VESA 200 FIXED INTERFACE ARMS

Fixed interface arms for screens with fixings up to VESA 200, which hook directly onto BT8390 mounting rails. Height adjustment screws allow screens to be levelled. Available in black.

2

BT8390-VESA200T

VESA 200 INTERFACE ARMS WITH TILT

Tilting interface arms for screens with fixings up to VESA 200, which hook directly onto BT8390 mounting rails. Height adjustment screws allow screens to be levelled and a tilt function allows an incremental tilt angle of up to +20°. Available in black.

3

BT8390-VESA400F

VESA 400 FIXED INTERFACE ARMS

Fixed interface arms for screens with fixings up to VESA 400, which hook directly onto BT8390 mounting rails. Height adjustment screws allow screens to be levelled. Available in black.

4

BT8390-VESA400T

VESA 400 INTERFACE ARMS WITH TILT

Tilting interface arms for screens with fixings up to VESA 400, which hook directly onto BT8390 mounting rails. Height adjustment screws allow screens to be levelled and a tilt function allows an incremental tilt angle of up to +20°. Available in black.

5

BT8390-VESA400MAF

VESA 400 FIXED INTERFACE ARMS WITH MICRO-ADJUSTMENT

Fixed interface arms for screens with fixings up to VESA 400, which hook directly onto BT8390 mounting rails. These arms feature 8-point micro-adjustment for a seamless alignment of multi-screen installations. Available in black.

6

BT8390-VESA400MAP

VESA 400 POP-OUT INTERFACE ARMS WITH MICRO-ADJUSTMENT

Interface arms for screens with fixings up to VESA 400, which hook directly onto BT8390 mounting rails. These arms feature a pop-out function for easy install and service access, as well as 8-point micro-adjustment for a seamless alignment of multi-screen installations. Available in black.

7

BT8390-VESA800F

VESA 800 FIXED INTERFACE ARMS

Ideal for mounting XL screens in landscape or portrait orientation, these fixed interface arms are designed for screens with fixings up to VESA 800 and hook directly onto a single or dual BT8390 mounting rails. Height adjustment screws allow screens to be levelled. Available in black.

8

BT8390-VESA1200F

VESA 1200 FIXED INTERFACE ARMS

Ideal for mounting XL screens in landscape or portrait orientation, these fixed interface arms are designed for screens with fixings up to VESA 1200 and hook directly onto dual BT8390 mounting rails. Height adjustment screws allow screens to be levelled. Available in black.

9

BT7564

VESA 600 X 400 INTERFACE ADAPTORS

These adaptors allow VESA 600 x 400 screens to be mounted in portrait orientation on VESA 400 interface arms. Also allows landscape VESA 600 x 400 configurations to be installed on shorter length BT8390 mounting rails. Available in black.

INDIVIDUAL COMPONENTS

POLES, CEILING/FLOOR MOUNTS & COLLARS

System X components integrate with B-Tech's Ø50mm pole mounting range to create one of the most versatile mounting systems available on the market today. Horizontal mounting rails simply fit onto poles using a B-Tech collar and collar fixing plate, they can then be fixed to the floor or ceiling (or both) using a variety of different ceiling mounts.

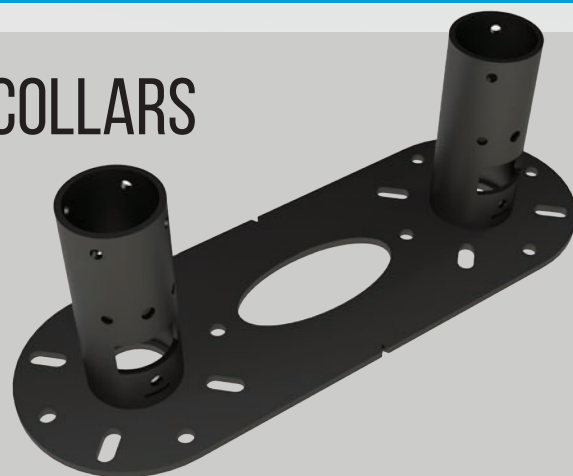

1



2



3



4



5



6



7



8



9



PRODUCT LIST



For more information about all other B-Tech products please scan the QR code below or visit www.btechavmounts.com alternatively, you can contact us at **(+44) 1327 300787** or info@btechavmounts.co.uk



1

BT7850

Ø50MM POLES

BT7850 poles can be used in an almost endless variety of different ways to create simple or complex structures - to which BT8390 mounting rails can be fitted. Available in 6 different lengths; **BT7850-025** (0.25m), **BT7850-050** (0.5m), **BT7850-100** (1m), **BT7850-150** (1.5m), **BT7850-200** (2m) & **BT7850-300** (3m) poles are available in a black, silver or chrome finish.

2

BT7853

Ø50MM HEAVY DUTY POLES

BT7853 poles work in the same way as BT7850 but are made from a thicker steel, resulting in a finished install with a much greater rigidity - ideal for supporting large, complex installations. Available in 2 lengths; **BT7853-200** (2m) and **BT7853-300** (3m) these poles are available in black only.

3

BT7851

TELESCOPIC CEILING MOUNT

The BT7851 ceiling mount features a telescopic Ø50mm pole with an adjustable drop of 600mm - 1000mm, to which BT8390 rails can be mounted. Available in black.

4

BT7822

HEAVY DUTY CEILING / FLOOR MOUNT

Made from heavy duty steel, the BT7822 is a robust mounting solution designed to mount Ø50mm poles to the floor or ceiling. Capable of supporting heavy loads, it is the ideal solution for ceiling mounted installs, ranging from basic setups to complex installations. Available in black or chrome.

5

BT7808

CEILING / WALL MOUNT WITH TILT

Designed to ceiling mount Ø50mm poles, the BT7808 features an adjustable tilt mechanism with a tilt range of up to 90°. This makes it ideal for installations mounted on angled ceilings. Available in black.

6

BT7807

HEAVY DUTY TWIN FLOOR / CEILING MOUNT

Made from heavy duty steel, the BT7807 is a robust, twin pole mounting solution designed to mount Ø50mm poles to the floor or ceiling. Capable of supporting heavy loads, it is the ideal solution for ceiling mounted twin pole installs, ranging from basic setups to complex installations. Available in black.

7

BT7831

WALL MOUNTING BRACKET

Designed to mount Ø50mm poles onto walls, the BT7831 is ideal for installs at locations where it is not possible to fix to the floor or ceiling (or both), or when there is a large section of wall behind the installation which is not strong enough to fix to. Available in black.

8

BT7841

Ø50MM 2-PIECE ACCESSORY COLLAR

This split collar allows mounts and other equipment to be fitted to B-Tech Ø50mm poles. Using a BT7841 with a BT8390 Collar Fixing Kit allows BT8390 Horizontal Mounting Rails to be used in pole mounted installations. The 2-piece design aids the installation process and allows retro-fitting to existing installations. Fixing points on either side of the collar allows back-to-back installations. Available in black.

9

BT7051

Ø50MM HEAVY DUTY ACCESSORY COLLAR

This heavy duty collar allows mounts and other equipment to be fitted to B-Tech Ø50mm poles. Using a BT7051 with a BT8390 Collar Fixing Kit allows BT8390 Horizontal Mounting Rails to be used in pole mounted installations. The dual fixing design provides a more rigid installation and fixing points on either side of the collar allows back-to-back installations. Available in black.

COMPONENT HOW-TO-GUIDE

HOW-TO-CREATE A BT8370 KIT FROM INDIVIDUAL COMPONENTS

EXAMPLE SHOWS BT8370-2X2 FOR 46" TO 60" SCREENS

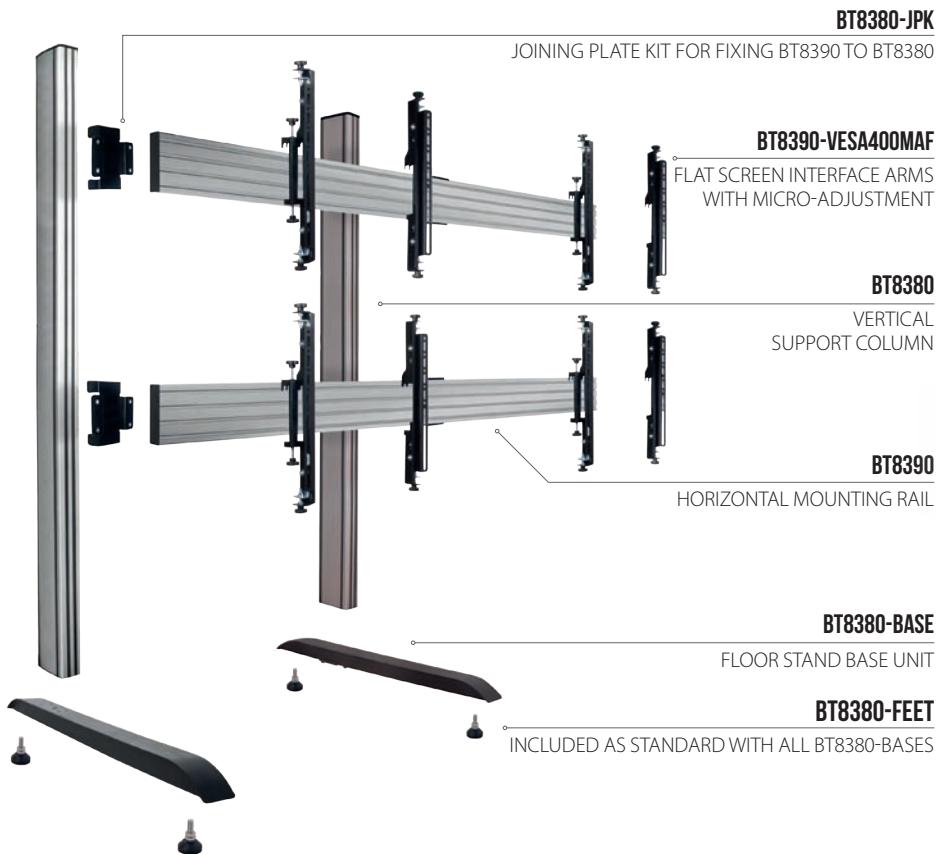

COMPONENT QTY CHART

The following chart shows the quantity of each component used to create the BT8370 standard kits.

COMPONENT REF	COLOURS AVAILABLE	BT8370-2X2 (FOR 46" TO 60")	BT8370-3X3 (FOR 46" TO 55")	BT8370-3X3-60 (FOR 55 TO 60")
BT8390-150	○	-	6	-
BT8390-175	○	-	-	6
BT8390-200	○	2	-	-
BT8390-EXT	○	-	3	3
BT8390-VESA400MAF	●	4	9	9
BT8380-JPK	●	4	9	9
BT8380-180	● ○	2	-	-
BT8380-240	● ○	-	3	3
BT8380-BASE	●	2	3	3
BT8390-SP	●	1	1	1
BT7564*	●	-	9	-

*Please note the BT7564 is only needed when mounting 55" screens with VESA 600 x 400 fixing patterns onto BT8370-3x3 installs.

COMPONENT HOW-TO-GUIDE

HOW-TO-CREATE A BT8371 KIT FROM INDIVIDUAL COMPONENTS

EXAMPLE SHOWS BT8371-3X3 FOR 46" TO 55" SCREENS

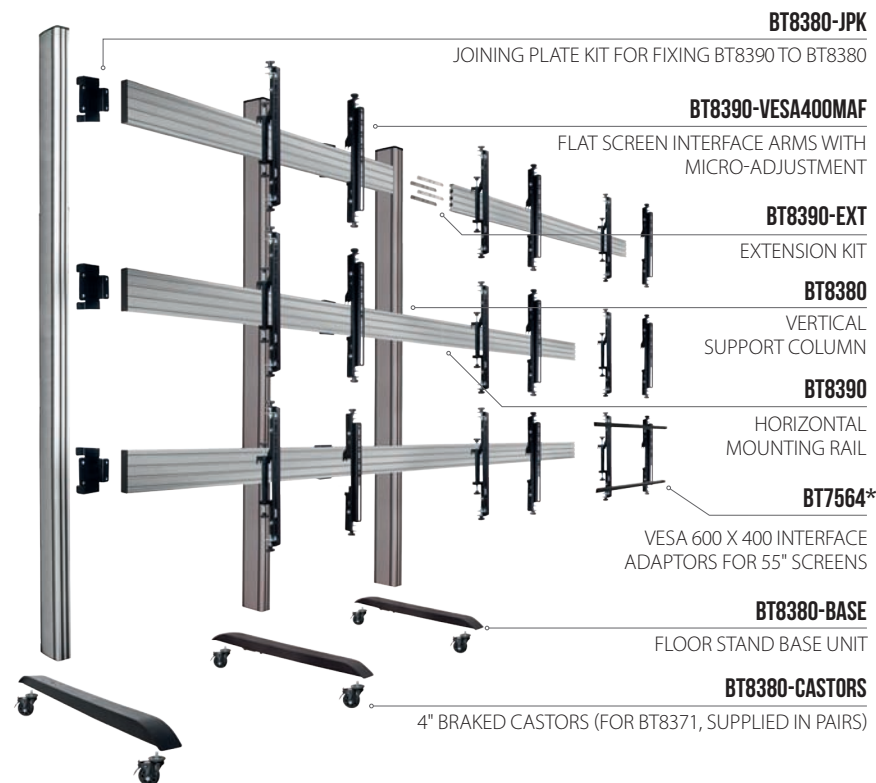

COMPONENT QTY CHART

The following chart shows the quantity of each component used to create the BT8371 standard kits.

COMPONENT REF	COLOURS AVAILABLE	BT8371-2X2 (FOR 46" TO 60")	BT8371-3X3 (FOR 46" TO 55")	BT8371-3X3-60 (FOR 55 TO 60")
BT8390-150	○	-	6	-
BT8390-175	○	-	-	6
BT8390-200	○	2	-	-
BT8390-EXT	○	-	3	3
BT8390-VESA400MAF	●	4	9	9
BT8380-JPK	●	4	9	9
BT8380-180	● ○	2	-	-
BT8380-240	● ○	-	3	3
BT8380-CASTORS (Pair)	●	2	3	3
BT8380-BASE	●	2	3	3
BT8390-SP	●	1	1	1
BT7564*	●	-	9	-

*Please note the BT7564 is only needed when mounting 55" screens with VESA 600 x 400 fixing patterns onto BT8371-3x3 installs.

COMPONENT HOW-TO-GUIDE

HOW-TO-CREATE A BT8372 KIT FROM INDIVIDUAL COMPONENTS

EXAMPLE SHOWS BT8372-2X2 FOR 46" TO 60" SCREENS

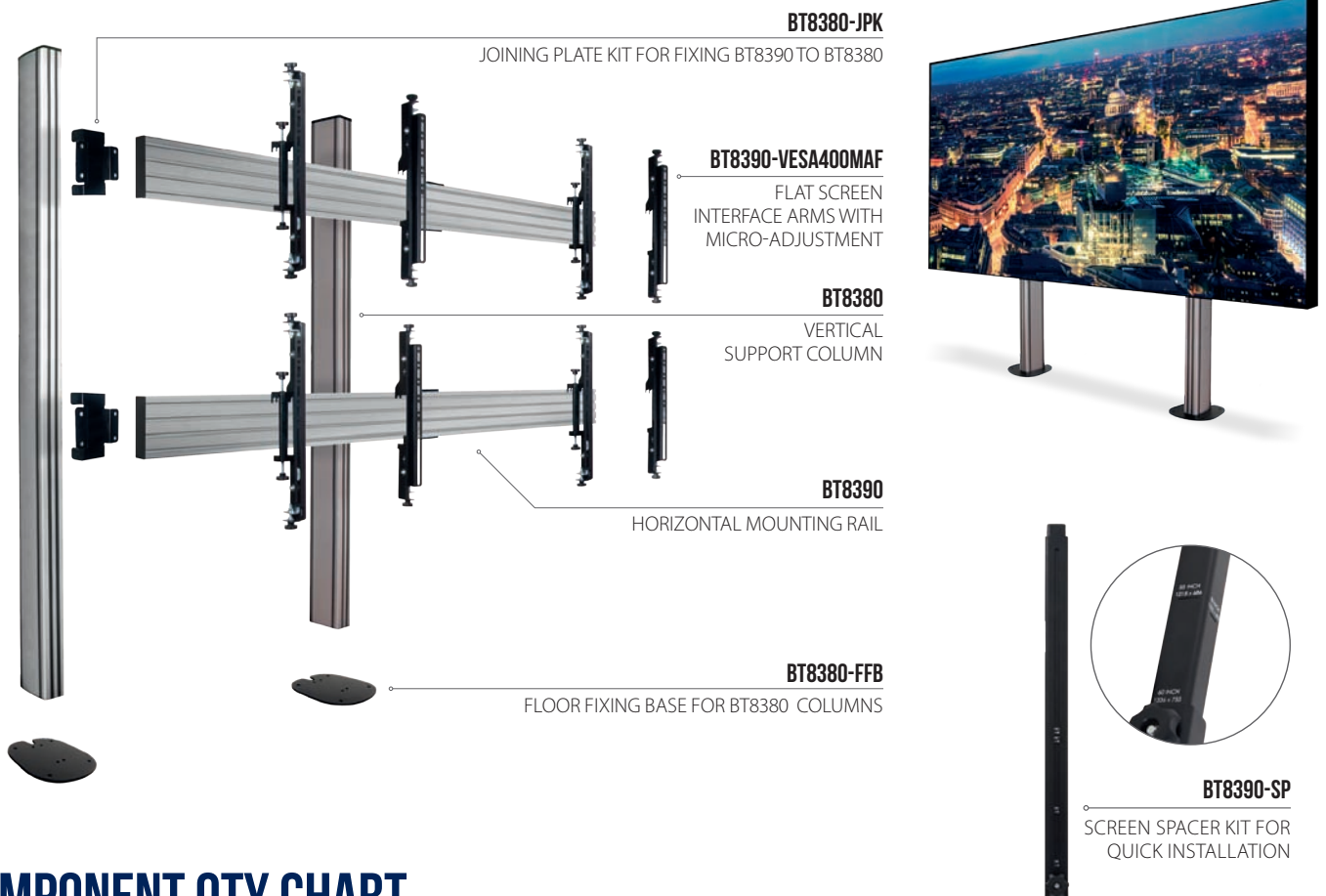

COMPONENT QTY CHART

The following chart shows the quantity of each component used to create BT8372 kits.

COMPONENT REF	COLOURS AVAILABLE	BT8372-2X2 (FOR 46" TO 60")	BT8372-3X3 (FOR 46" TO 55")	BT8372-3X3-60 (FOR 55 TO 60")
BT8390-150	○	-	6	-
BT8390-175	●	-	-	6
BT8390-200	○	2	-	-
BT8390-EXT	●	-	3	3
BT8390-VESA400MAF	●	4	9	9
BT8380-JPK	●	4	9	9
BT8380-180	● ○	2	-	-
BT8380-240	● ○	-	3	3
BT8380-FFB	●	2	3	3
BT8390-SP	●	1	1	1
BT7564*	●	-	9	-

*Please note the BT7564 is only needed when mounting 55" screens with VESA 600 x 400 fixing patterns onto BT8372-3x3 installs.



SYSTEM X PRODUCT VIDEOS

INSTALLATION OVERVIEW VIDEOS



BT8370 / BT8371

UNIVERSAL VIDEO WALL STANDS

Scan the QR code below to view the installation overview video for the BT8370 & BT8371 universal video wall stands, or visit www.btechavmounts.com/videos for all other B-Tech videos.



BT8330

UNIVERSAL MENU BOARD MOUNT

Scan the QR code below to view the installation overview video for the BT8330 universal menu board mounting system or visit www.btechavmounts.com/videos for all other B-Tech videos.

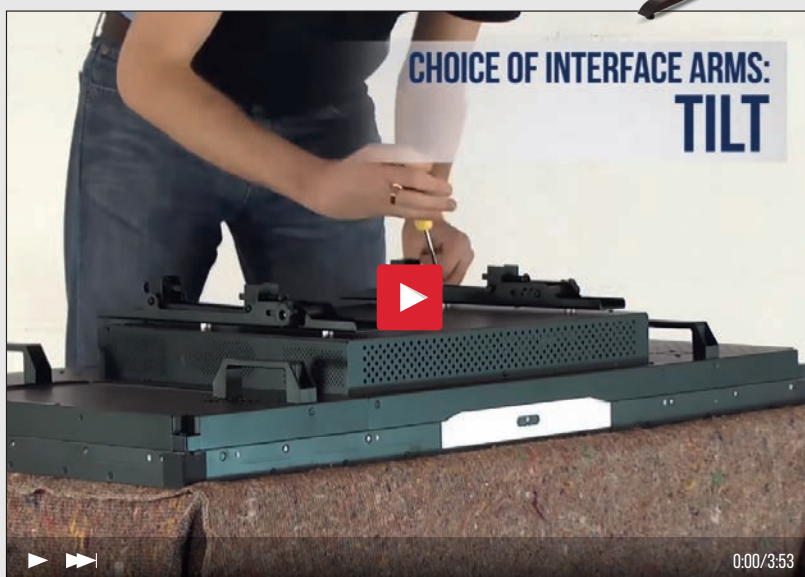

PRODUCT DEMONSTRATION AND INSTALLATION VIDEOS

Visit the video page on the B-Tech website to discover other product demonstration and installation videos. www.btechavmounts.com/videos



COMPONENT HOW-TO-GUIDE

HOW-TO-CREATE A WALL MOUNTED BT8330 KIT FROM INDIVIDUAL COMPONENTS

EXAMPLE SHOWS BT8330-WL4X1-32-T FOR 32" SCREENS

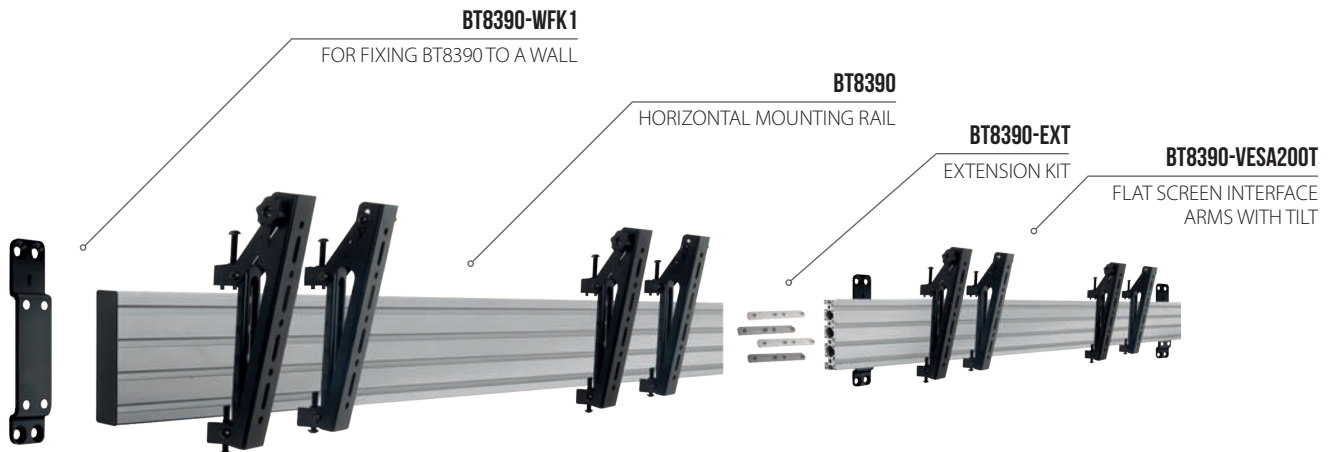

COMPONENT QTY CHART

The following chart shows the quantity of each component used to create a BT8330-WL4X1-32-T.

COMPONENT REF	COLOURS AVAILABLE	BT8330-WL4X1-32-T
BT8390-070	○	1
BT8390-150	○	-
BT8390-175	○	-
BT8390-200	○	1
BT8390-EXT	○	1
BT8380-WFK1	●	3
BT8390-VESA200F	●	-
BT8390-VESA200T	●	4
BT8390-VESA400F	●	-
BT8390-VESA400T	●	-



CREATE YOUR OWN MOUNTING SYSTEM ONLINE

Menu board installations can vary dramatically from one install to the next, so the BT8330 has been designed on a modular principle with over 2000 different configurations available! Please see page 40 for information about our unique online configuration tool designed to create custom installations to suit your own requirements.

Try it now at:

www.btechavmounts.com/systemx-configurator



COMPONENT HOW-TO-GUIDE

HOW-TO-CREATE A CEILING MOUNTED BT8330 KIT FROM INDIVIDUAL COMPONENTS

EXAMPLE SHOWS BT8330-CL3X1-42-T-100 FOR 42" SCREENS

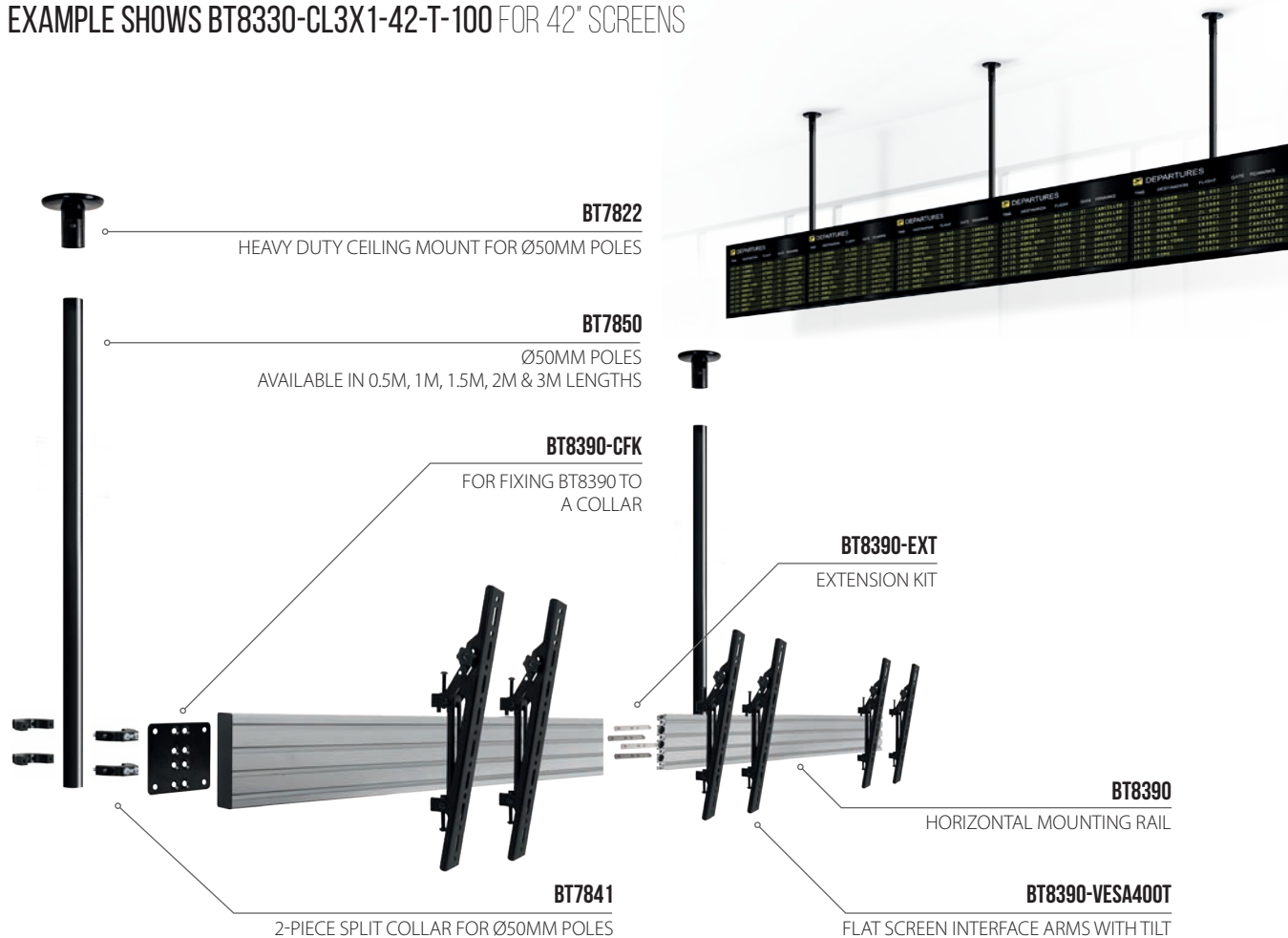

COMPONENT QTY CHART

The following chart shows the quantity of each component used to create a BT8330-CL3X1-42-T-100.

COMPONENT REF	COLOURS AVAILABLE	BT8330-CL3X1-32-T-100
BT8390-070	○	1
BT8390-150	○	-
BT8390-175	○	-
BT8390-200	○	1
BT8390-EXT	○	1
BT8390-CFK	●	2
BT8390-VESA200F	●	-
BT8390-VESA200T	●	-
BT8390-VESA400F	●	-
BT8390-VESA400T	●	3
BT7822	● ○	2
BT7850	● ○ ●	2 (1m)
BT7841 or BT7051	●	4 or 2

 **CREATE YOUR OWN MOUNTING SYSTEM ONLINE**

Menu board installations can vary dramatically from one install to the next, so the BT8330 has been designed on a modular principle with over 2000 different configurations available! Please see page 40 for information about our unique online configuration tool designed to create custom installations to suit your own requirements.

Try it now at:
www.btechavmounts.com/systemx-configurator



COMPONENT HOW-TO-GUIDE

HOW-TO-CREATE A WALL MOUNTED BT8340 KIT FROM INDIVIDUAL COMPONENTS

EXAMPLE SHOWS BT8340-WL2X2-46-M FOR 46" SCREENS

34

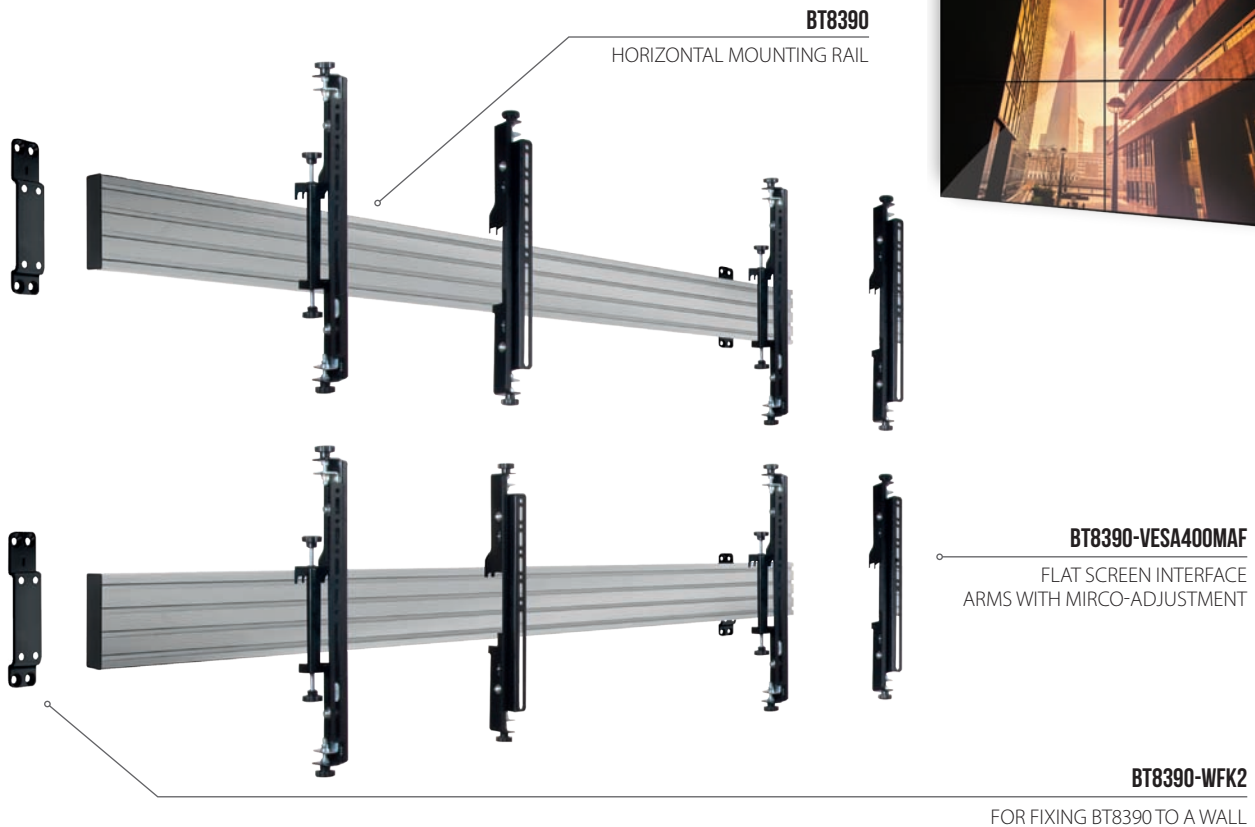

COMPONENT QTY CHART

The following chart shows the quantity of each component used to create a BT8340-WL2X2-46-M.

COMPONENT REF	COLOURS AVAILABLE	BT8340-WL2X2-46-M
BT8390-070	○	-
BT8390-150	○	-
BT8390-175	○	2
BT8390-200	○	-
BT8390-EXT	○	-
BT8380-WFK2	●	4
BT8390-VESA400MAF	●	4

CREATE YOUR OWN MOUNTING SYSTEM ONLINE

Menu board installations can vary dramatically from one install to the next, so the BT8340 has been designed on a modular principle with over 2000 different configurations available! Please see page 40 for information about our unique online configuration tool designed to create custom installations to suit your own requirements.

Try it now at:

www.btechavmounts.com/systemx-configurator



COMPONENT HOW-TO-GUIDE

HOW-TO-CREATE A CEILING MOUNTED BT8340 KIT FROM INDIVIDUAL COMPONENTS

EXAMPLE SHOWS BT8340-CL3X3-46-T-200 FOR 46" SCREENS

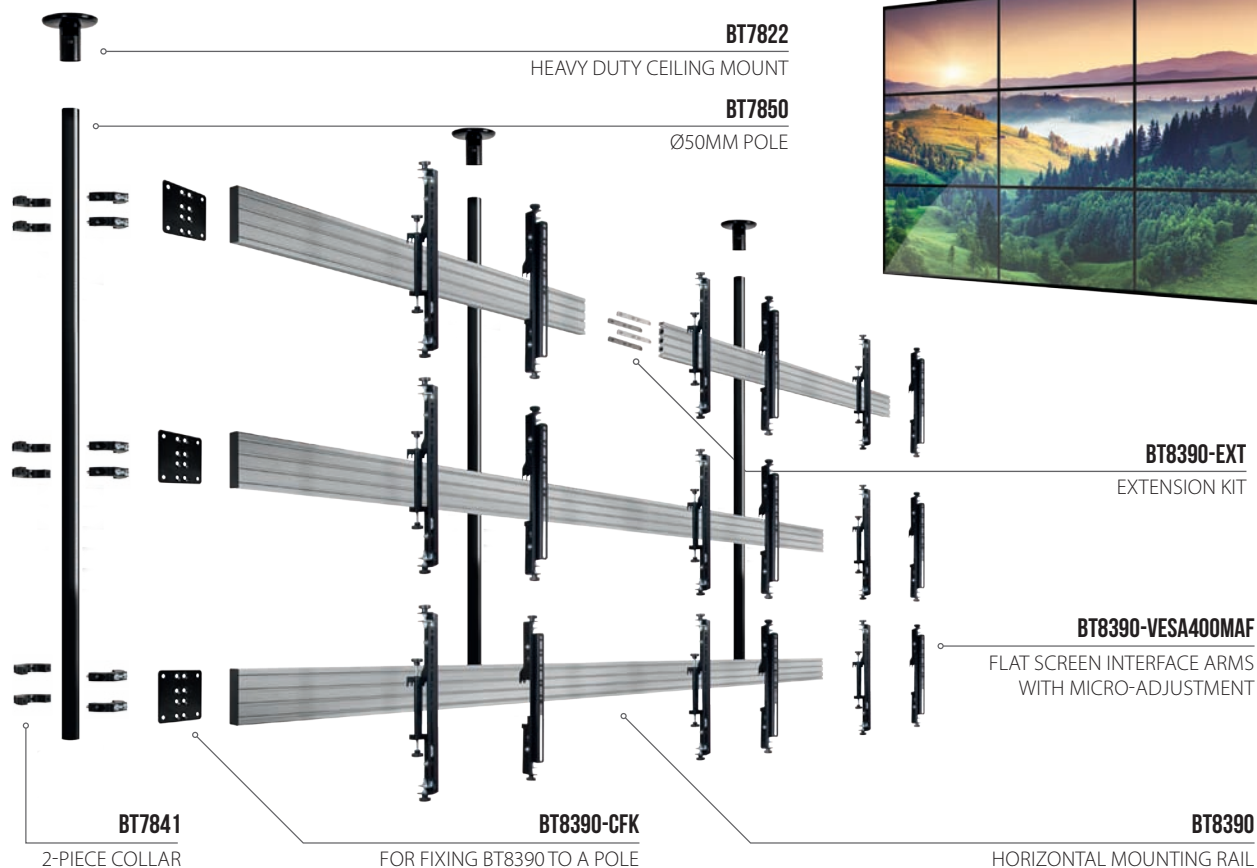

COMPONENT QTY CHART

The following chart shows the quantity of each component used to create at BT8340-CL3X3-46-M-200.

COMPONENT REF	COLOURS AVAILABLE	BT8340-CL3X3-46-M-200
BT8390-070	○	3
BT8390-150	○	-
BT8390-175	○	-
BT8390-200	○	3
BT8390-EXT	○	3
BT8390-CFK	●	9
BT8390-VESA400MAF	●	9
BT7822	● ○	3
BT7850	● ○	3 (2m)
BT7841 or BT7051	●	18 or 9



CREATE YOUR OWN MOUNTING SYSTEM ONLINE

Menu board installations can vary dramatically from one install to the next, so the BT8340 has been designed on a modular principle with over 2000 different configurations available! Please see page 40 for information about our unique online configuration tool designed to create custom installations to suit your own requirements.



Try it now at:

www.btechavmounts.com/systemx-configurator

SMALL SCREEN INSTALLS

FLAT SCREEN WALL MOUNTS

As an alternative option, B-Tech's professional range of flat screen wall mounts can fit directly onto System X horizontal mounting rails. This allows multi-screen installations using screens with VESA 100 or VESA 200 x 100 mounting patterns - with a choice of options that include fixed, tilt or tilt and swivel.

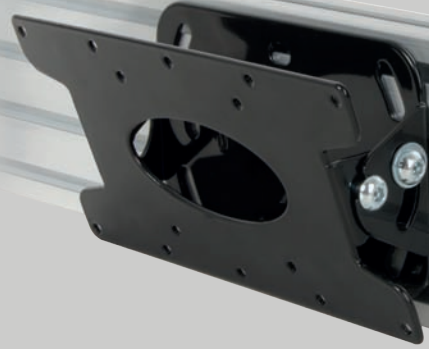

1



2



3



4



5



6



PRODUCT LIST



For more information about all other B-Tech products please scan the QR code below or visit www.btechavmounts.com alternatively, you can contact us at **(+44) 1327 300787** or info@btechavmounts.co.uk



1

BT7510

ULTRA-SLIM, FIXED FLAT - SMALL

Designed for screens up to 23" with 50 x 50, 75 x 75 or 100 x 100 VESA mounting patterns, this flat screen wall mount has an ultra-slim design for a discreet, fixed installation. Available in black.

2

BT7511

FLAT SCREEN WALL MOUNT WITH TILT - SMALL

Designed for screens up to 23" with 75 x 75 or 100 x 100 VESA mounting patterns, this flat screen wall mount features a tilting interface which, when mounted onto BT8390 mounting rails, has a tilt range of +17° / -10°. Available in black.

3

BT7518

FLAT SCREEN WALL MOUNT WITH TILT AND SWIVEL - SMALL

Designed for screens up to 23" with 75 x 75 or 100 x 100 VESA mounting patterns, this flat screen wall mount features a tilt and swivel interface which, when mounted onto BT8390 mounting rails, has a tilt range of +17° / -10° and swivel range of 50°. Available in black.

4

BT7521

ULTRA-SLIM, FIXED FLAT SCREEN WALL MOUNT - MEDIUM

Designed for screens up to 32" with 75 x 75, 100 x 100 or 200 x 100 VESA mounting patterns, this flat screen wall mount has an ultra-slim design for a discreet, fixed installation. Available in black.

5

BT7522

FLAT SCREEN WALL MOUNT WITH TILT - MEDIUM

Designed for screens up to 32" with 75 x 75, 100 x 100 or 200 x 100 VESA mounting patterns, this flat screen wall mount features a tilting interface which, when mounted onto BT8390 mounting rails, has a tilt range of +/-40°. Available in black.

6

BT7524

FLAT SCREEN WALL MOUNT WITH TILT AND SWIVEL - MEDIUM

Designed for screens up to 32" with 75 x 75, 100 x 100 or 200 x 100 VESA mounting patterns, this flat screen wall mount features a tilt and swivel interface which, when mounted onto BT8390 mounting rails, has a tilt range of +17° / -10° and swivel range of 50°. Available in black or silver.



ACCESSORISE YOUR INSTALL

SHELVES, MEDIA PLAYERS & SPEAKERS

A range of different accessories can be added to any System X installation by bolting a desired accessory mounting solution directly onto the horizontal mounting rails or vertical support columns. Typical accessories include media players such as an Apple TV®, Blu-Ray® player or Loudspeakers.



1



2



3



4

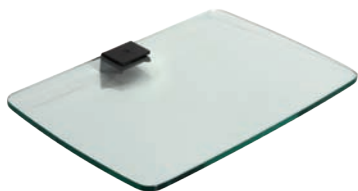

5



6



7



8



9



PRODUCT LIST



For more information about all other B-Tech products please scan the QR code below or visit www.btechavmounts.com alternatively, you can contact us at **(+44) 1327 300787** or info@btechavmounts.co.uk



1

BT8390-SA

SHELF ADAPTOR FOR SYSTEM X

This shelf adaptor allows shelves to be fitted to System X installations. Ideal for video conferencing applications, the adaptor allows a shelf to be mounted either above or below screens. Available in black.

2

BT7863

VC CAMERA SHELF

This shelf is designed to mount a Video Conferencing Camera and is ideal for use with the BT8390-SA to mount a camera above or below screens. Available in black.

3

BT7172

SMALL GLASS AV SHELF

This small AV accessory shelf is made from 10mm thick tempered glass and is ideal for adding AV devices up to 350mm x 300mm (such as laptops or DVD players) to installations. Fits directly to BT8390 mounting rails or BT8380 support columns and is available in black or clear glass.

4

BT7173

MEDIUM GLASS AV SHELF

This medium sized AV accessory shelf is made from 10mm thick tempered glass and is ideal for adding AV devices up to 470mm x 310mm (such as laptops or DVD players) to installations. Fits directly to BT8390 mounting rails or BT8380 support columns and is available in black or clear glass.

5

BT7174

LARGE GLASS AV SHELF

This large AV accessory shelf is made from 10mm thick tempered glass and is ideal for adding AV devices up to 500mm x 380mm (such as laptops or DVD players) to installations. Fits directly to BT8390 mounting rails or BT8380 support columns and is available in black or clear glass.

6

BT7032

LARGE AV ACCESSORY SHELF

This large AV accessory shelf is made from a durable powder coated steel and is ideal for adding AV devices up to 500mm x 380mm (such as laptops or DVD players) to installations. Fits directly to BT8390 mounting rails or BT8380 support columns and is available in black.

7

BT7860

APPLE TV® 2ND & 3RD GENERATION MOUNT

The BT7860 is designed to mount 2nd and 3rd Generation Apple TVs® and can be bolted straight onto BT8390 mounting rails or BT8380 support columns. Features +/-90° tilt and 75° swivel, security screws to help prevent unauthorised removal and is available in black.

8

BT7880

APPLE TV® 4TH GENERATION MOUNT

The BT7880 is designed to mount 4th Generation Apple TVs® and can be bolted straight onto BT8390 mounting rails or BT8380 support columns. Features +/-90° tilt and 75° swivel, security screws to help prevent unauthorised removal and is available in black.

9

BT77

SIDE CLAMPING LOUDSPEAKER MOUNTS

BT77 speaker mounts fit directly onto BT8380 support columns, allowing speakers of to 25kg to be mounted directly to trolley or floor stand installations. Mounts come in pairs and feature +/-7° tilt and 360° swivel and are available in black or white.

ONLINE CONFIGURATION TOOL

SPECIFY CUSTOM REQUIREMENTS ONLINE

The System X Range is available as a highly comprehensive component system which can be used to create bespoke video wall, menu board and other multi-screen mounting solutions according to your requirements. Our online configuration tool makes it quick and easy to specify a complete solution that meets your needs. Select a freestanding, mobile, wall or ceiling mounted setup and then choose screen size and quantity, orientation, interface arm function as well as pole length/leg height (where applicable).



EXAMPLE INSTALLATIONS THAT CAN BE SPECIFIED USING OUR ONLINE CONFIGURATION TOOL...

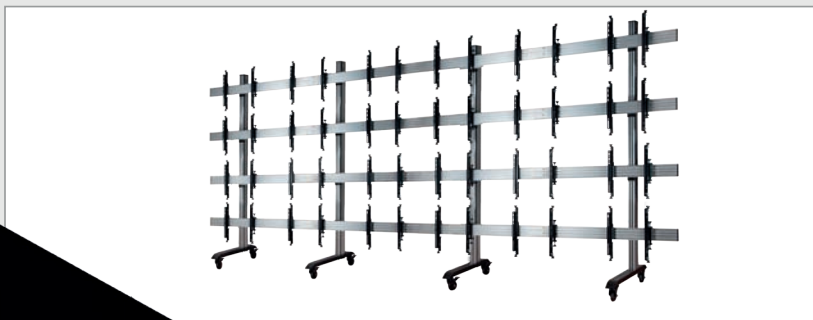

BESPOKE CONFIGURATIONS MADE EASY



Try now at www.btechavmounts.com/systemx-configurator

HOW-TO-USE

BT8330 & BT8340

WALL AND POLE MOUNTED VIDEO WALLS AND MENU BOARDS

BT8370 & BT8371

FREESTANDING AND MOBILE VIDEO WALL STANDS

STEP 1:

Select wall or ceiling mounted and preferred orientation

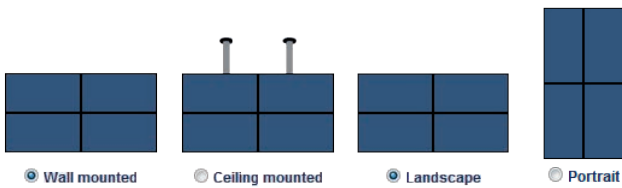

1

STEP 1:

Select Freestanding or Mobile and preferred orientation

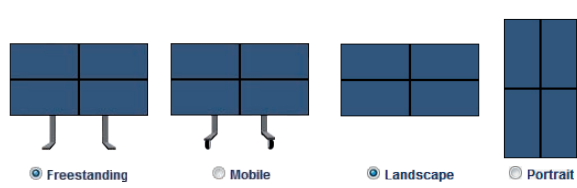

STEP 2:

Select from the drop down boxes to create a solution that is ideal for you

SCREEN SIZE	INTERFACE FUNCTION	SCREENS PER ROW	NUMBER OF ROWS
Please select	Please select	Please select	Please select
32"	Fixed	2	2
42"	Micro-adjustment	3	3
46"		4	4
47"		5	5
55"		6	6
60"			
65"			

2

STEP 2:

Select from the drop down boxes to create a solution that is ideal for you

SCREEN SIZE	INTERFACE FUNCTION	SCREENS PER ROW	NUMBER OF ROWS
Please select	Please select	Please select	Please select
32"	Fixed	2	2
42"	Micro-adjustment	3	3
46"		4	4
47"		5	5
55"		6	6
60"			
65"			

STEP 3:

Select desired pole length if creating a ceiling mounted solution

3

STEP 3:

Select desired leg height

STEP 4:

Click the configure button to generate your solution and part code



4

STEP 4:

Click the configure button to generate your solution and part code

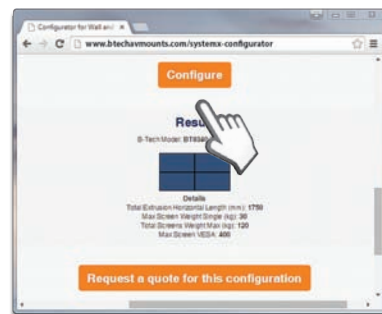

STEP 5:

Request a quote and we'll do the rest.

5

STEP 5:

Request a quote and we'll do the rest.



COMING SOON FROM B-TECH

1



NEW AND UPDATED PRODUCTS COMING SOON TO B-TECH'S RANGE OF PROFESSIONAL MOUNTING SOLUTIONS

Continual investment into research and development means B-Tech's range of professional mounting solutions is constantly being updated to ensure the range remains one of the most comprehensive collections of products available on the market today.

2



3



4



5



6



7



8

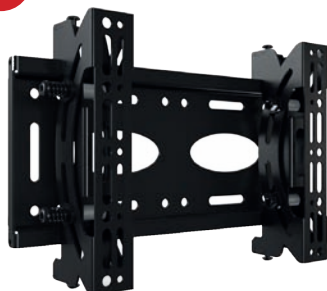

9



10



PRODUCT LIST



For more information about the products listed on this page and for information on all other B-Tech products please visit our website at www.btechavmounts.com or contact us at info@btechavmounts.co.uk



1

BT8312

ULTRA-SLIM POP-OUT VIDEO WALL

This modular video wall mount can be used to create unlimited video wall configurations in both landscape and portrait format. The ultra-slim BT8312 features a pop-in, pop-out system which enables quick and easy access to the rear of mounted screens for servicing and maintenance and 8 point micro-adjustment, making accurate screen alignment quick and easy. Available in black.

2

BT8355

FREESTANDING LED PANEL MOUNT

This mounting solution is designed to support LED display panels and can be ordered to your specific configuration requirements for any type of panel being used. A lightweight aluminium frame is easy to install and fixes to heavy duty steel bases which can be positioned backwards if desired - so they are hidden from sight when viewing the screens.

3

BT6157

STACKABLE HEAVY DUTY PROJECTOR MOUNT

Designed for projectors up to 75kg, this heavy duty mount can be stacked to create a column of XL projectors. The projectors fix to a slide out tray which allows quick and easy servicing without needing to disassemble any part of the installation. Pitch, yaw and roll micro-adjustment allows easy alignment of projected images and cable management is included for a neat and tidy installation. Available in black.

4

BT6165

STACKABLE HEAVY DUTY PROJECTOR MOUNT WITH ENHANCED PITCH

The BT6165 can be used independently or in conjunction with the BT6157 and can also be used to mount stacks of XL projectors up to 75kg. The BT6165 has the same great features of the BT6157 but has a much greater tilt range and a taller cage to accommodate this. Available in black.

5

BT8322

DIGITAL SIGNAGE MEDIA PLAYER AND FLAT SCREEN MOUNT WITH TILT

This combination mount allows a flat screen and a digital signage or media player to be mounted to the wall. The media player housing keeps the device secure whilst being hidden behind the screen. The mount also has a tilt function to ensure the mounted screen can be positioned at the perfect viewing angle. Available in black.

6

BT7396

WALL MOUNT FOR TABLET ENCLOSURES

The BT7396 is a wall mounting bracket that, when used with the BT7390 Tablet Enclosure, allows a tablet to be mounted to a wall. Cable management is included to allow tablets to be charged whilst in use. Available in black, silver or white.

7

BT7835

TRUSS MOUNT FOR Ø50MM POLES

Adjustable adaptor which allows Ø50mm poles to be attached to truss systems, scaffolding and other horizontal poles. Available in black.

8

BT8430

UNIVERSAL FLAT SCREEN WALL MOUNT WITH TILT - MEDIUM

Designed for screens up to 45" with mounting patterns up to VESA 200 x 200, this flat screen wall mount features B-Tech's 'Torsion-Tilt' mechanism and is available in black.

9

BT8431

UNIVERSAL FLAT SCREEN WALL MOUNT WITH TILT - LARGE

Designed for screens up to 55" with mounting patterns up to VESA 400 x 400, this flat screen wall mount features B-Tech's 'Torsion-Tilt' mechanism and is available in black.

10

BT8432

UNIVERSAL FLAT SCREEN WALL MOUNT WITH TILT - EXTRA-LARGE

Designed for screens up to 80" with mounting patterns up to VESA 800 x 500, this flat screen wall mount features B-Tech's 'Torsion-Tilt' mechanism and is available in black.

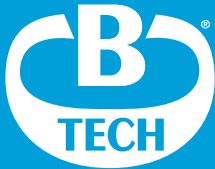

BETTER BY DESIGN™

B-TECH AUDIO VIDEO MOUNTS



Designed & Engineered in the UK

INTERNATIONAL GROUP OF COMPANIES

INTERNATIONAL HEAD OFFICE

UK
 B-TECH INTERNATIONAL LTD
 TEL: +44 (0)1327 300787
 EMAIL: INFO@BTECHAVMOUNTS.CO.UK

EUROPE

BELGIUM
 B-TECH PRO-AV BVBA
 TEL: +32 (0)2 720 9271
 EMAIL: INFO@BTECHPROAV.COM

GERMANY
 B-TECH DEUTSCHLAND GMBH
 TEL: +49 (0)3322 4291712
 EMAIL: INFO@BTECHDEUTSCHLAND.DE

SPAIN
 B-TECH INTERNATIONAL (IBERIA) SL
 TEL: +34 93 640 24 79
 EMAIL: INFO@BTECHIBERIA.COM

MENA & SAARC

DUBAI
 B-TECH AUDIO VISUAL
 ACCESSORIES TRADING LLC
 TEL: (+971) 4 3574855
 EMAIL: SALES@BTECHAVMOUNTS.AE

APAC

CHINA
 NINGBO B-TECH INTERNATIONAL
 TRADING CO., LTD
 TEL: (+86) 574 8810 3861
 EMAIL: INFO@BTECHASIA.COM

VIETNAM
 B-TECH INTERNATIONAL
 DESIGN AND MANUFACTURING (VIETNAM) LTD
 TEL: +84 (0)46 2870 500
 EMAIL: INFO@BTECHAVMOUNTS.VN

ASEAN

SINGAPORE
 B-TECH AV MOUNTS PTE LTD
 TEL: (+65) 6841 2988
 EMAIL: INFO@BTECHAVMOUNTS.COM.SG

© 2016 January B-Tech International Limited, All rights reserved.

The information in this catalogue reflects the current technical specifications at the time of print. We reserve the right to change the technical or physical specifications without prior notice. The B-Tech name, the B-Tech logo, Better by Design, System 2 and System X are all registered trademarks of B-Tech International Ltd. All B-Tech images and symbols are exclusive property of B-Tech International Ltd. B-Tech accept no liability for loss or damage caused by improper installation or mounting on unstable structures. E&OE. CA-SX-V1.1-260116-UK